

VoltMax

Electric Boiler

INSTALLATION AND OPERATION MANUAL



Your *VoltMax Electric Boiler* was carefully assembled and checked at the factory to ensure its proper functioning for many years. The following information and safety measures are provided to enable proper installation, operation, and maintenance of this product.

It is imperative that all persons who are expected to install, operate or adjust this boiler should read these instructions carefully.

Any questions regarding the operation, maintenance, service or warranty of this electric boiler should be directed to the installer or to a skilled technician.

When all installation steps have been completed, keep this installation manual in a safe place (near the boiler) for future reference.



THERMO 2000 INC.

Printed in Canada

Revised: Avril 2024

TABLE OF CONTENTS

SECTION 1 : TECHNICAL SPECIFICATIONS	4
SECTION 2 : INTRODUCTION	11
2.1 LOCAL INSTALLATION REGULATIONS	11
2.2 CORROSIVE ENVIRONMENT.....	11
2.3 INSPECTION UPON RECEPTION	11
2.4 TO BE CHECKED	11
SECTION 3 : INSTALLATION	12
3.1 SAFETY MEASURES	12
3.2 LOCATION.....	12
3.3 CLEARANCES	12
3.4 PIPING INSTALLATION.....	12
3.4.1 Boiler piping connection	13
3.4.2 Auxiliary boiler piping connection.....	13
3.4.3 Safety valve.....	13
3.4.4 System pressure control and expansion tank	14
3.4.5 Water pressure makeup regulator	14
3.4.6 Air bleeder.....	14
3.4.7 THERMO-MANOMETER	14
3.4.8 Circulating pump.....	14
3.4.9 Drain faucet.....	15
3.4.10 STRAINER	15
3.4.11 Pressure loss	16
3.5 ELECTRICAL CONNECTIONS	22
3.5.1 Main electrical supply	22
3.5.2 Pump supply	22
3.5.3 Connection of external signals to the controller	22
SECTION 4 : CONTROLLER OPERATION	26
4.1 USER INTERFACE	26
4.1.1 Symbol description.....	26
4.1.2 Control panel	27
4.1.3 Navigation and adjustments.....	27
4.1.4 Main menu navigation.....	28
4.1.5 Navigation in boiler setting	29
4.2 MAIN MENU	32
4.2.1 Boiler status.....	32
4.2.2 Boiler configuration	32
4.2.3 User setting.....	32
4.2.4 Clock setting.....	33
4.2.5 Consumption	33
4.3 BOILER SETTINGS	33
4.3.1 Heating mode W1.....	34
4.3.2 Heating mode W2/DHW	35
4.3.3 Pump setting.....	35
4.3.4 Capacity limiting	35
4.3.5 Auxiliary boiler	36
4.3.6 Limit setting	37
4.3.7 Alarm.....	38
4.3.8 Communication	38
4.3.9 Config. BACnet.....	39
4.3.10 Occupation	40
4.3.11 BOOST Mode.....	40
4.3.12 Stage override.....	41
4.3.13 Warm weather shutdown.....	41
4.3.14 Change password.....	41

4.4	ETHERNET	41
4.4.1	Web PORTAL	41
4.4.2	Alarm notification Email	41
4.5	BOILER STATUS DISPLAY SETTINGS	43
4.6	HEATING MODE W1 SETTINGS	45
4.6.1	FIXED MODE	45
4.6.2	OUTDOOR RESET MODE	46
4.6.3	MODE: DDC 0-10VDC	47
4.7	W2 MODE SET-POINT TEMPERATURE SETTINGS	48
4.7.1	W2 MODE	48
4.7.2	DHW MODE	48
4.8	POWER LIMITATION MENU SETTINGS	48
4.8.1	MANUAL MODE	49
4.8.2	0-10 VDC MODE	49
4.8.3	T. ext MODE	50
4.8.4	Schedule MODE	51
4.9	AUXILIARY BOILER SETTINGS	51
4.9.1	BACKUP MODE	52
4.9.2	EXTERNAL CONTACT MODE	53
4.9.3	ManuAl MODE	53
4.9.4	Bi-Energy MODE	53
4.10	LIMIT CONFIGURATION MENU SETTINGS	55
4.11	CONFIG. ALARM MENU SETTINGS	56
4.12	OCCUPATION MENU SETTINGS	57
4.13	BOOST MENU SETTINGS	58
4.14	WARM WEATHER SHUTDOWN MENU SETTINGS	58
SECTION 5 : BOILER START UP		59
5.1	STARTUP PREPARATION	59
5.2	ADJUSTEMENT OF THE CONTROLLER OPERATING PARAMETERS	59
5.3	STARTUP PROCEDURE	60
SECTION 6 : TROUBLESHOOTING		61
6.1	WARNING LIGHTS	61
6.2	OPERATING PROBLEM IDENTIFICATION	61
6.2.1	External HL / LWCO	61
6.2.2	Sensor (SE)	61
6.2.3	Low limit (LL)	61
6.2.4	Flow (F)	62
6.2.5	Current (A)	62
6.2.6	HL temperature (HL)	62
6.2.7	Low pressure (P)	62
6.2.8	High pressure (P)	62
6.2.9	Battery low level 	62
6.2.10	Lock out 	62
6.3	FUSES	64
6.4	CONTACTOR	64
6.5	HEATING ELEMENTS	64
6.6	TEMPERATURE SENSOR	64
6.7	EXTERNAL HIGH LIMIT CONTROL	64
6.8	INTERNAL CLOCK	64
SECTION 7 : MAINTENANCE		65
7.1	BOILER WATER PIPING	65
7.2	PRESSURE RELIEF VALVE	65
7.3	AIR PURGE	65
7.4	ELECTRICAL INSPECTION	65

SECTION 1 : TECHNICAL SPECIFICATIONS

Table 1 : VoltMax 600 VAC / 60 Hz / 3 Phases¹

Model	BTU/h	kW	Amps	480V Elements	Relay Stages ²	SCR Stage	max. power supply (MCM) ³	Config.
VoltMax 30	102 360	30	36.1	2 x 15 kW	1 x 15 kW	1 x 15 kW	3 x 2/0 AWG	A
VoltMax 36	122 832	36	43.3	2 x 18 kW	1 x 18 kW	1 x 18 kW	3 x 2/0 AWG	A
VoltMax 45	153 540	45	54.1	3 x 15 kW	2 x 15 kW	1 x 15 kW	3 x 2/0 AWG	A
VoltMax 54	184 248	54	65	3 x 18 kW	2 x 18 kW	1 x 18 kW	3 x 2/0 AWG	A
VoltMax 60	204 720	60	72.2	4 x 15 kW	3 x 15 kW	1 x 18 kW	3 x 2/0 AWG	A
VoltMax 72	245 664	72	86.6	4 x 18 kW	3 x 18 kW	1 x 18 kW	3 x 2/0 AWG	A
VoltMax 75	255 900	75	90.2	5 x 15 kW	4 x 15 kW	1 x 15 kW	3 x 2/0 AWG	A
VoltMax 90	307 80	90	108.3	5 x 18 kW	4 x 18 kW	1 x 18 kW	3 x 2/0 AWG	A
VoltMax 99	337 788	99	119.1	3 x 15 kW 3 x 18 kW	2 x 33 kW	1 x 33 kW	3 x 2/0 AWG	B
VoltMax 108	368 496	108	129.9	6 x 18 kW	2 x 36 kW	1 x 36 kW	3 x 2/0 AWG	B
VoltMax 120	409 440	120	144.3	8 x 15 kW	3 x 30 kW	1 x 30 kW	3 x 2/0 AWG	B
VoltMax 132	450 384	132	158.8	4 x 15 kW 4 x 18 kW	3 x 33 kW	1 x 33 kW	3 x 2/0 AWG	B
VoltMax 144	491 328	144	173.2	8 x 18 kW	3 x 36 kW	1 x 36 kW	3 x 2/0 AWG	B
VoltMax 150	511 800	150	180.4	10 x 15 kW	4 x 30 kW	1 x 30 kW	3 x 350	B
VoltMax 165	562 980	165	198.5	5 x 15 kW 5 x 18 kW	4 x 33 kW	1 x 33 kW	3 x 350	B
VoltMax 180	614 160	180	216.5	10 x 18 kW	4 x 36 kW	1 x 36 kW	3 x 350	B
VoltMax 192	655 104	192	230.9	8 x 15 kW 4 x 18 kW	3 x 48 kW	1 x 48 kW	3 x 350	C
VoltMax 204	696 048	204	245.4	8 x 18 kW 4 x 15 kW	3 x 51 kW	1 x 51 kW	3 x 350	C
VoltMax 225	767 700	225	270.6	15 x 15 kW	4 x 45 kW	1 x 45 kW	3 x 350	C
VoltMax 240	818 880	240	288.7	10 x 15 kW 5 x 18 kW	4 x 48 kW	1 x 48 kW	3 x 350	C
VoltMax 255	870 060	255	306.7	10 x 18 kW 5 x 15 kW	4 x 51 kW	1 x 51 kW	3 x 350	C
VoltMax 288	982 656	288	346.4	12 x 15 kW 6 x 18 kW	5 x 48 kW	1 x 48 kW	3 x 500	C
VoltMax 306	1 044 072	306	368.1	12 x 18 kW 6 x 15 kW	5 x 51 kW	1 x 51 kW	3 x 500	C
VoltMax 315	1 074 780	315	378.9	21 x 15 kW	6 x 45 kW	1 x 45 kW	3 x 500	C
VoltMax 336	1 146 432	336	404.1	14 x 15 kW 7 x 18 kW	6 x 48 kW	1 x 48 kW	3 x 600	C
VoltMax 357	1 218 084	357	429.4	14 x 18 kW 7 x 15 kW	6 x 51 kW	1 x 51 kW	3 x 600	C
VoltMax 384	1 310 208	384	461.9	16 x 15 kW 8 x 18 kW	7 x 48 kW	1 x 48 kW	6 x 350	C
VoltMax 408	1 392 096	408	490.7	16 x 18 kW 8 x 15 kW	7 x 51 kW	1 x 51 kW	6 x 350	C

¹ Electrical supply 600 V 3 phase (L1-L2-L3) with 3 conductors Cu or AL ,90 °C with a ground.

² The 30 kW stage is composed of two 15 kW elements.

The 33 kW stage is composed of one 15 kW element and one 18 kW element.

The 36 kW stage is composed of 2 18 kW elements.

The 45 kW stage is composed of three 15 kW elements.

The 48 kW stage is composed of two 15 kW elements and one 18 kW element.

The 51 kW stage is composed of one 15 kW element and two 18 kW elements.

The 54 kW stage is composed of three 18 kW elements.

³-Maximum capacity of the boilers connection terminals

Table 2 : VoltMax 480 VAC / 60 Hz / 3 Phases¹

Model	BTU/h	kW	Amps	480V Elements	Relay Stages ²	SCR Stage	max. power supply (MCM) ³	Config.
VoltMax 30	102 360	30	36.1	2 x 15 kW	1 x 15 kW	1 x 15 kW	3 x 2/0 AWG	A
VoltMax 36	122 832	36	43.3	2 x 18 kW	1 x 18 kW	1 x 18 kW	3 x 2/0 AWG	A
VoltMax 45	153 540	45	54.1	3 x 15 kW	2 x 15 kW	1 x 15 kW	3 x 2/0 AWG	A
VoltMax 54	184 248	54	65	3 x 18 kW	2 x 18 kW	1 x 18 kW	3 x 2/0 AWG	A
VoltMax 60	204 720	60	72.2	4 x 15 kW	3 x 15 kW	1 x 18 kW	3 x 2/0 AWG	A
VoltMax 72	245 664	72	86.6	4 x 18 kW	3 x 18 kW	1 x 18 kW	3 x 2/0 AWG	A
VoltMax 75	255 900	75	90.2	5 x 15 kW	4 x 15 kW	1 x 15 kW	3 x 2/0 AWG	A
VoltMax 90	307 80	90	108.3	5 x 18 kW	4 x 18 kW	1 x 18 kW	3 x 2/0 AWG	A
VoltMax 99	337 788	99	119.1	3 x 15 kW 3 x 18 kW	2 x 33 kW	1 x 33 kW	3 x 2/0 AWG	B
VoltMax 108	368 496	108	129.9	6 x 18 kW	2 x 36 kW	1 x 36 kW	3 x 2/0 AWG	B
VoltMax 120	409 440	120	144.3	8 x 15 kW	3 x 30 kW	1 x 30 kW	3 x 2/0 AWG	B
VoltMax 132	450 384	132	158.8	4 x 15 kW 4 x 18 kW	3 x 33 kW	1 x 33 kW	3 x 2/0 AWG	B
VoltMax 144	491 328	144	173.2	8 x 18 kW	3 x 36 kW	1 x 36 kW	3 x 2/0 AWG	B
VoltMax 150	511 800	150	180.4	10 x 15 kW	4 x 30 kW	1 x 30 kW	3 x 350	B
VoltMax 165	562 980	165	198.5	5 x 15 kW 5 x 18 kW	4 x 33 kW	1 x 33 kW	3 x 350	B
VoltMax 180	614 160	180	216.5	10 x 18 kW	4 x 36 kW	1 x 36 kW	3 x 350	B
VoltMax 192	655 104	192	230.9	8 x 15 kW 4 x 18 kW	3 x 48 kW	1 x 48 kW	3 x 350	C
VoltMax 204	696 048	204	245.4	8 x 18 kW 4 x 15 kW	3 x 51 kW	1 x 51 kW	3 x 350	C
VoltMax 225	767 700	225	270.6	15 x 15 kW	4 x 45 kW	1 x 45 kW	3 x 350	C
VoltMax 240	818 880	240	288.7	10 x 15 kW 5 x 18 kW	4 x 48 kW	1 x 48 kW	3 x 350	C
VoltMax 255	870 060	255	306.7	10 x 18 kW 5 x 15 kW	4 x 51 kW	1 x 51 kW	3 x 350	C
VoltMax 288	982 656	288	346.4	12 x 15 kW 6 x 18 kW	5 x 48 kW	1 x 48 kW	3 x 500	C
VoltMax 306	1 044 072	306	368.1	12 x 18 kW 6 x 15 kW	5 x 51 kW	1 x 51 kW	3 x 500	C
VoltMax 315	1 074 780	315	378.9	21 x 15 kW	6 x 45 kW	1 x 45 kW	3 x 500	C
VoltMax 336	1 146 432	336	404.1	14 x 15 kW 7 x 18 kW	6 x 48 kW	1 x 48 kW	3 x 600	C
VoltMax 357	1 218 084	357	429.4	14 x 18 kW 7 x 15 kW	6 x 51 kW	1 x 51 kW	3 x 600	C
VoltMax 384	1 310 208	384	461.9	16 x 15 kW 8 x 18 kW	7 x 48 kW	1 x 48 kW	6 x 350	C
VoltMax 408	1 392 096	408	490.7	16 x 18 kW 8 x 15 kW	7 x 51 kW	1 x 51 kW	6 x 350	C

¹ Electrical supply 600 V 3 phase (L1-L2-L3) with 3 conductors Cu or AL ,90 °C with a ground.

² The 30 kW stage is composed of two 15 kW elements.

The 33 kW stage is composed of one 15 kW element and one 18 kW element.

The 36 kW stage is composed of 2 18 kW elements.

The 45 kW stage is composed of three 15 kW elements.

The 48 kW stage is composed of two 15 kW elements and one 18 kW element.

The 51 kW stage is composed of one 15 kW element and two 18 kW elements.

The 54 kW stage is composed of three 18 kW elements.

³-Maximum capacity of the boilers connection terminals

Table 3 : VoltMax 240 VAC / 60 Hz / 3 Phases¹

Model	BTU/h	kW	Amps	240V Elements	Relay Stages ²	SCR Stage	max. power supply (MCM) ³	Config.
VoltMax 30	102 360	30	72	2 x 15 kW	1 x 15 kW	1 x 15 kW	3 x 2/0 AWG	A
VoltMax 36	122 832	36	87	2 x 18 kW	1 x 18 kW	1 x 18 kW	3 x 2/0 AWG	A
VoltMax 45	153 540	45	109	3 x 15 kW	2 x 15 kW	1 x 15 kW	3 x 2/0 AWG	A
VoltMax 54	184 248	54	130	3 x 18 kW	2 x 18 kW	1 x 18 kW	3 x 2/0 AWG	A
VoltMax 60	204 720	60	145	4 x 15 kW	3 x 15 kW	1 x 15 kW	3 x 350	A
VoltMax 72	245 664	72	174	4 x 18 kW	3 x 18 kW	1 x 18 kW	3 x 350	A
VoltMax 75	255 900	75	181	5 x 15 kW	4 x 15 kW	1 x 15 kW	3 x 350	A
VoltMax 105	358 260	105	253	7 x 15 kW	6 x 15 kW	1 x 15 kW	3 x 500	C
VoltMax 120	409 440	120	289	8 x 15 kW	7 x 15 kW	1 x 15 kW	3 x 500	C
VoltMax 126	429 912	126	303	7 X 18 kW	6 X 18 kW	1 x 18 kW	3 x 500	C
VoltMax 144	491 328	144	347	8 x 18 kW	7 x 18 kW	1 x 18 kW	3 x 500	C

¹ Electrical supply 240 V 3 phase (L1-L2-L3) with 3 conductors Cu or AL ,90 °C with a ground.

²-Maximum capacity of the boilers connection terminals

Table 4 : VoltMax 208 VAC / 60 Hz / 3 Phases¹

Model	BTU/h	kW	Amps	240V Elements ²	Relay Stages ³	SCR Stage	max. power supply (MCM) ³	Config.
VoltMax 23	76 770	22,5	63	2 x 15 kW	1 x 11,25 kW	1 x 11,25 kW	3 x 2/0 AWG	A
VoltMax 27	92 124	27	76	2 x 18 kW	1 x 13,5 kW	1 x 13,5 kW	3 x 2/0 AWG	A
VoltMax 34	116 008	34	94	3 x 15 kW	2 x 11,25 kW	1 x 11,25 kW	3 x 2/0 AWG	A
VoltMax 41	138 186	40,5	113	3 x 18 kW	2 x 13,5 kW	1 x 13,5 kW	3 x 2/0 AWG	A
VoltMax 45	153 540	45	126	4 x 15 kW	3 x 11,25 kW	1 x 11,25 kW	3 x 2/0 AWG	A
VoltMax 54	184 248	54	151	4 x 18 kW	3 x 13,5 kW	1 x 13,5 kW	3 x 350	A
VoltMax 56	191 072	56	157	5 x 15 kW	4 x 11,25 kW	1 x 11,25 kW	3 x 350	A
VoltMax 68	230 310	67,5	188	5 x 18 kW	4 x 13,5 kW	1 x 13,5 kW	3 x 350	A
VoltMax 79	268 695	78,8	219	7 x 15 kW	6 x 11,25 kW	1 x 11.25 kW	3 x 350	C
VoltMax 90	307 080	90	250	8 x 15 kW	7 x 11,25 kW	1 x 11.25 kW	3 x 500	C
VoltMax 95	322 434	94,5	263	7 X 18 kW	6 X 13,5 kW	1 x 13.5 kW	3 x 500	C
VoltMax 108	368 496	108	300	8 x 18 kW	7 x 13,5 kW	1 x 13.5 kW	3 x 500	C

¹ Electrical supply 208 V 3 phase (L1-L2-L3) with 3 conductors Cu or AL ,90 °C with a ground.

² 240V electrical element operated at 208V

³-Maximum capacity of the boilers connection terminals

Table 5 : VoltMax 240 VAC / 60 Hz / 1 Phase¹

Model	BTU/h	kW	Amps	240V Elements	Relay Stages ²	SCR Stage	max. power supply (MCM) ³	Config.
VoltMax 30	102 360	30	125	6 x 5 kW	2 x 10 kW	1 x 10 kW	2 x 350	A
VoltMax 36	122 832	36	150	6 x 6 kW	2 x 12 kW	1 x 12 kW	2 x 350	A
VoltMax 40	136 480	40	167	8 x 5 kW	3 x 10 kW	1 x 10 kW	2 x 350	A
VoltMax 48	163 776	48	200	8 x 6 kW	3 x 12 kW	1 x 12 kW	2 x 350	A
VoltMax 55	187 660	55	230	5 x 5 kW 5 x 6 kW	4 x 11 kW	1 x 11 kW	2 x 500	A
VoltMax 60	204 720	60	250	10 x 6 kW	4 x 12 kW	1 x 12 kW	2 x 500	A
VoltMax 66	225 192	66	275	6 x 5 kW 6 x 6 kW	5 x 11 kW	1 x 11 kW	2 x 500	A
VoltMax 72	245 664	72	300	12 x 6 kW	5 x 12 kW	1 x 12 kW	2 x 500	A
VoltMax 77	262 724	77	321	7 x 5 kW 7 x 6 kW	7 x 11 kW	1 x 11 kW	2 x 500	C
VoltMax 80	272 960	80	333	16 x 5 kW	8 x 10 kW	1 x 10 kW	2 x 600	C
VoltMax 84	386 608	84	350	14 x 6 kW	7 X 12 kW	1 x 12 kW	2 x 600	C
VoltMax 88	300 256	88	366	8 x 5 kW 8 x 6 kW	8 x 11 kW	1 x 11 kW	4 x300	C
VoltMax 96	327 552	96	400	16 x 6 kW	8 x 12 kW	1 x 12 kW	4 x 300	C

¹ Electrical supply 240 V 2 phase (L1-L2) with 2 conductors Cu or AL ,90 °C with a ground.

² The 10 kW stage is composed of two 5kW elements

The 11 kW stage is composed of one 5 kW element et one 6 kW element

The 12 kW stage is composed of two 6 kW elements.

³-Maximum capacity of the boilers connection terminals

Table 6 : VoltMax 208 VAC / 60 Hz / 1 Phase¹

Model	BTU/h	kW	Amps	240V Elements ²	Relay Stages ³	SCR Stage	max. power supply (MCM) ⁴	Config.
VoltMax 23	76 770	22,5	109	6 x 5 kW	2 x 7,5 kW	1 x 7,5 kW	2 x 350	A
VoltMax 27	92 124	27	131	6 x 6 kW	2 x 9 kW	1 x 9 kW	2 x 350	A
VoltMax 30	102 360	30	145	8 x 5 kW	3 x 7,5 kW	1 x 7,5 kW	2 x 350	A
VoltMax 36	122 832	36	174	8 x 6 kW	3 x 9 kW	1 x 9 kW	2 x 350	A
VoltMax 41	139 892	41	199	5 x 5 kW 5 x 6 kW	4 x 8,25 kW	1 x 8,25 kW	2 x 350	A
VoltMax 45	153 540	45	217	10 x 6 kW	4 x 9 kW	1 x 9 kW	2 x 350	A
VoltMax 50	168 894	49,5	239	6 x 5 kW 6 x 6 kW	5 x 8,25 kW	1 x 8,25 kW	2 x 500	A
VoltMax 54	184 248	54	261	12 x 6 kW	5 x 9 kW	1 x 9 kW	2 x 500	A
VoltMax 58	197 043	57.75	278	7 x 5 kW 7 x 6 kW	6 x 8.25 kW	1 x 8.25 kW	2 x 500	C
VoltMax 60	204 720	60	288	16 x 5 kW	7 x 7.5 kW	1 x 7.5 kW	2 x 500	C
VoltMax 63	214 956	63	303	14 x 6 kW	6 X 9 kW	1 x 7.5 kW	2 x 500	C
VoltMax 66	225 192	66	317	8 x 5 kW 8 x 6 kW	7 x 8.25 kW	1 x 8.25 kW	2 x 500	C
VoltMax 72	245 664	72	346	16 x 6 kW	7 x 9 kW	1 x 9 kW	2 x 600	C

¹ Electrical supply 240 V 2 phase (L1-L2) with 2 conductors Cu or AL ,90 °C with a ground.

² 240 electrical element operated at 208V

³ The 7.5 kW stage is composed of two 5kW elements

The 8.25 kW stage is composed of one 5 kW element et one 6 kW element

The 9 kW stage is composed of two 6 kW elements.

⁴ Maximum capacity of the boilers connection terminals

Table 7 : Maximum operating pressure for each configuration

Configuration	A	B	C
Pression maximale d'opération standard	70 PSI	125 PSI	160 PSI
Soupape de sûreté standard	60 PSI	125 PSI	150 PSI

BOILER DIMENSIONS AND CHARACTERISTICS : CONFIGURATION A

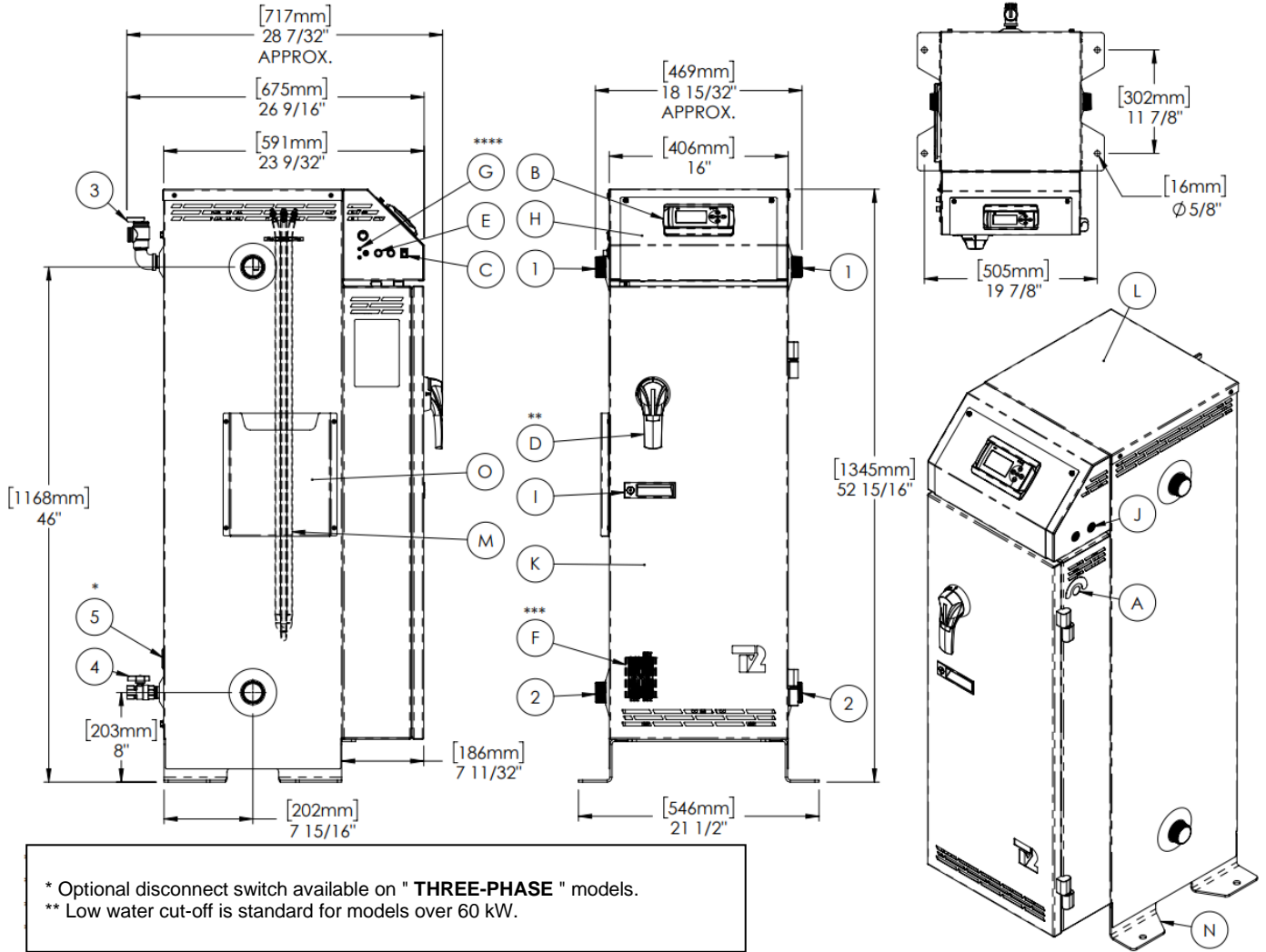

* Optional disconnect switch available on " **THREE-PHASE** " models.
 ** Low water cut-off is standard for models over 60 kW.

BOILER CONNECTIONS		
1	Boiler outlet	1 1/2" NPT M
2	Boiler inlet	1 1/2" NPT M
3	Pressure relief valve	3/4" NPT F
4	Drain valve	3/4" NPT F
5*	Access to the return sensor	1/2" NPT F

MIN. CLEARANCES FOR INSTALLATION & MAINTENANCE	
Left and Right sides	3" / 76mm
Rear	3" / 76mm
Front	24" / 610mm
Bottom	0" / 0mm
Top	32" / 813mm

GENERAL INFORMATIONS	
Weight	310lbs / 141kg
Water Volume	11 Us gal. / 41.6 liters
Max. operating pressure	STANDARD: 70 psi OPTION: 125 PSI *

*Available at 125PSI (See Shop Drawing Config. B)

COMPONENTS IDENTIFICATION	
A	Electrical main supply
B	Boiler controller
C	"On/Off" switch
D**	Disconnect switch & rotary handle
E	Fuses for controls
F***	Solid state SCR relay
G****	Low water cut-off, test button and indicator lights
H	Electrical control access door
I	Door handle for electric access with lock
J	Electrical control wires access holes
K	Access door power circuit
L	Access cover to Heating elements
M	Heating elements
N	Attachment legs

BOILER DIMENSIONS AND CHARACTERISTICS : CONFIGURATION B

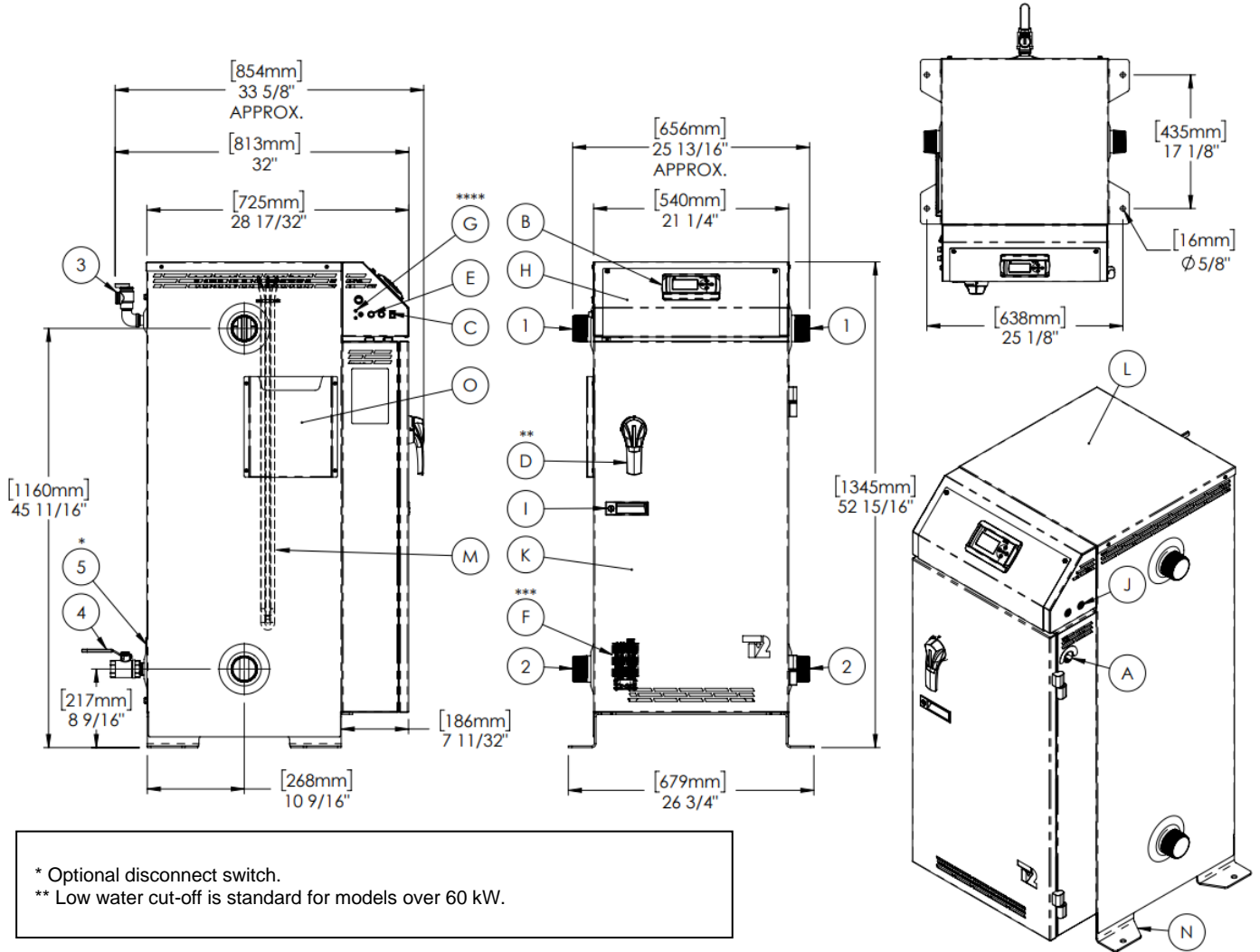

* Optional disconnect switch.
 ** Low water cut-off is standard for models over 60 kW.

BOILER CONNECTIONS		
1	Boiler outlet	2 1/2" NPT M
2	Boiler inlet	2 1/2" NPT M
3	Pressure relief valve	3/4" NPT F
4	Drain valve	3/4" NPT F
5*	Access to the return sensor	1/2" NPT F

MIN. CLEARANCES FOR INSTALLATION & MAINTENANCE	
Left and Right sides	3" / 76mm
Rear	3" / 76mm
Front	24" / 610mm
Bottom	0" / 0mm
Top	32" / 813mm

GENERAL INFORMATIONS	
Weight	550lbs / 250kg
Water Volume	30 gal. Us / 113.5 liters
Max. operating pressure	STANDARD: 125 psi

COMPONENTS IDENTIFICATION	
A	Electrical main supply
B	Boiler controller
C	"On/Off" switch
D**	Disconnect switch & rotary handle
E	Fuses for controls
F***	Solid state SCR relay
G****	Low water cut-off, test button and indicator lights
H	Electrical control access door
I	Door handle for electric access with lock
J	Electrical control wires access holes
K	Access door power circuit
L	Access cover to Heating elements
M	Heating elements
N	Attachment legs

BOILER DIMENSIONS AND CHARACTERISTICS : CONFIGURATION C

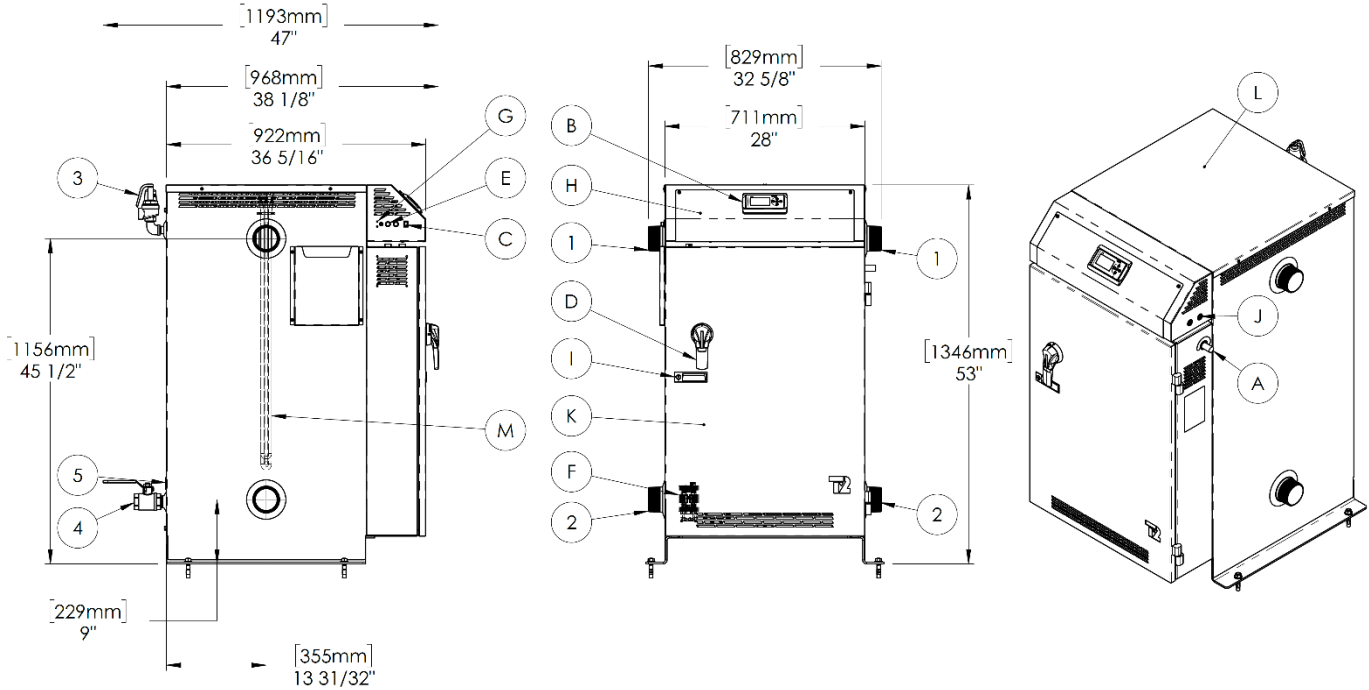

* Optional disconnect switch available on "THREE-PHASE" models.

BOILER CONNECTIONS		
1	Boiler outlet	3 " NPT M
2	Boiler inlet	3 " NPT M
3	Pressure relief valve	3/4" NPT F
4	Drain valve	1 1/4 " NPT F
5*	Access to the return sensor	1/2 " NPT F

MIN. CLEARANCES FOR INSTALLATION & MAINTENANCE	
Left and Right sides	6" / 152mm
Rear	6" / 152mm
Front	24" / 610mm
Bottom	0" / 0mm
Top	32" / 813mm

GENERAL INFORMATIONS	
Weight	1200 lbs / 545 kg
Water Volume	62 Us gal. / 235 liters
Max. operating pressure	STANDARD: 160psi

COMPONENTS IDENTIFICATION	
A	Electrical main supply
B	Boiler controller
C	"On/Off" switch
D*	Disconnect switch & rotary handle
E	Fuses for controls
F	Solid state SCR relay
G	Low water cut-off, test button and indicator lights
H	Electrical control access door
I	Door handle for electric access with lock
J	Electrical control wires access holes
K	Access door power circuit
L	Access cover to Heating elements
M	Heating elements



General Safety Precautions

Be sure to read and understand the entire Installation & operation manual before attempting to install or to operate this water heater. Pay attention to the following General Safety Precautions. Failure to follow these warnings could cause property damage, bodily injury or death. Should you have any problems understanding the instructions in this manual, **STOP**, and get help from a qualified installer or technician

SECTION 2 : INTRODUCTION



WARNING

These important safeguards and instruction appearing in this manual are not meant to cover all possible conditions and situations that may occur. Common sense, caution and care are factors that cannot be built into every product. These factors must be supplied by the person(s) caring for and operating the unit.

2.1 LOCAL INSTALLATION REGULATIONS

This electric boiler must be installed in accordance with these instructions and in conformity with local codes, or in the absence of local codes, with the National Plumbing Code and the National Electric Code, current edition. In any case where instructions in this manual differ from local or national codes, the local or national codes take precedence.

2.2 CORROSIVE ENVIRONMENT

The electric boiler must not be installed near an air duct supplying corrosive atmosphere or with high humidity content. When a boiler defect is caused by such conditions, the warranty will not apply.

2.3 INSPECTION UPON RECEPTION

Inspect the electric boiler for possible shipping damage. The manufacturer's responsibility ceases upon delivery of goods to the carrier in good condition. The Consignee must file any claims for damage, shortage in shipments, or non-delivery immediately against the carrier.

2.4 TO BE CHECKED

Please refer to the rating plate on the unit to ensure that you have the correct model and voltage in hand.

List of components shipped with the unit:

- Pressure relief valve
- Drain valve
- Outdoor temperature sensor ,
(Located inside the control panel of the unit)



AVERTISSEMENT

The electric boiler should not be installed where it may damage the adjacent structures or lower floors in the event of leakage of the tank or connections. If this cannot be avoided, install a non-flammable tray or bowl under the boiler to collect and drain water from leaks.

NOTE: Any tray or cuvette MUST conform to local codes.

SECTION 3 : INSTALLATION



MISE EN GARDE

The manufacturer's warranty does not cover any damage or defect caused by installation, or attachment, or use of any special attachment other than those authorized by the manufacturer into, onto, or in conjunction with the water heater. The use of such unauthorized devices may shorten the life of the boiler and may endanger life and property. The manufacturer disclaims any responsibility for such loss or injury resulting from the use of such unauthorized devices

3.1 SAFETY MEASURES

Any commercial installation will be equipped with a safety valve that limits the maximum working pressure to the maximum design pressure of the tank. The maximum operating pressure of the VoltMax boiler is presented in Table 7 depending on the model and configuration.

The boiler is equipped with an automatic high limit temperature control set at 210°F (99°C) and a second manual high limit temperature settable.

This electric boiler is designed to operate at a maximum operating temperature of 200 ° F (93 ° C). The boiler is designed for use in a hot water heating system only.

The heat transfer fluid must be water or an antifreeze water / propylene glycol solution or an antifreeze water / ethylene glycol solution specially designed for heating systems. The maximum concentration of solution must be a maximum of 50%.

3.2 LOCATION

The electric boiler should be installed in a clean, dry location. Long hot water lines should be insulated to conserve water and energy. The electric boiler and water lines should be protected from exposure to freezing temperature.

The boiler can be mounted vertically directly on a solid surface.

The electric boiler must be located or protected to avoid risk of physical damage, such as from moving vehicles, flooding, etc.

The location must have sufficient ventilation to maintain an ambient temperature not exceeding 80°F (27°C).

To prevent condensation on the boiler walls, boiler temperature should not be maintained below the condensation temperature (dew-

point temperature) of the ambient. The operating temperature of the boiler must not be lower than the condensation temperature (dew temperature) relative to the ambient humidity content.

3.3 CLEARANCES

For adequate inspection and servicing the following minimum clearance is necessary:

Table 8 : Boiler Clearances

Sides**	6 inches / 76 mm
Bottom	0 inches / 0 mm
Top*	32 inches / 813 mm
Front	24 inches / 610 mm
Back	6 inches / 76 mm

* A minimum clearance of 32 inches. For units equipped with 18 kW elements (25 in. For 15 kW elements) is required for possible replacement of heating elements.

**** The left side of the control panel, where the boiler ON / OFF switch is located, must remain visible after installation. Otherwise, a label indicating its location must be affixed to the control panel indicating its position.**

3.4 PIPING INSTALLATION

The location of the inlet and outlet piping shall conform to the various configurations shown in Figure 1. You will find typical connection diagrams to the Figure 3, Figure 4 and Figure 5.

The VoltMax boiler is designed to be operated on a closed-circuit piping system. Therefore, it should not be used to heat open air tanks

Figure 1 : Possible pipe flow configurations

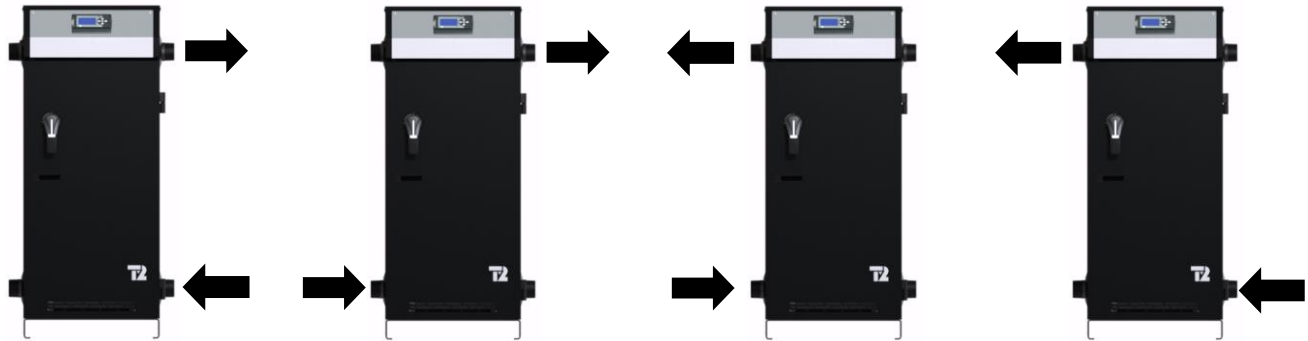

3.4.1 BOILER PIPING CONNECTION

The boiler is equipped with two fittings on each side of the unit. One of the bottom connections must be used for the heating return (inlet) and one of the top connections must be used for supplying the heating system (outlet).

Installation of plugs on the inlet and exhaust ducts is required to facilitate the disconnection and maintenance of the boiler.

When connecting different types of pipes (galvanized steel and copper), use dielectric joints (insulation) to protect the boiler and piping.

Use only new and clean pipes as piping connection to the boiler. Local codes or regulations may dictate the exact type of material to be used.

Insulate all piping containing hot water, especially in an unheated environment.

Install faucets for easy maintenance.

Install a thermometer on the inlet and outlet duct(s).

Close the unused openings on the boiler. **Do not block the safety valve**, this may cause loss, damage or injury.

3.4.2 AUXILIARY BOILER PIPING CONNECTION

When an auxiliary boiler used as back up is twinned to the VoltMax boiler to act as a back-up controlled by the VOTLMAX, the auxiliary

boiler shall be installed downstream of the electric boiler as shown on Figure 5 and 7.

3.4.3 SAFETY VALVE

The installation of a safety valve is an integral part of the boiler's installation. The trigger point of the valve must not exceed the design pressure of the boiler as indicated on its registration and identification plate. The valve must comply with the ASME Boiler and Pressure Vessel Code and limit the boiler maximum operating pressure. The safety valve is a security component, not a control component.

The capacity of the safety valve expressed in BTU / hour must equal or exceed the rating on the nameplate of the boiler (s).

A safety valve adjusted to the maximum design pressure of the boiler has been installed at the factory. The latter can be replaced by a valve with a lower trigger pressure, but its BTU / hour capacity must not be lower than the maximum boiler power.

Connect the exhaust of the safety valve to a drain line. The lower end of this conduit shall be at least 6" (15 cm) from the floor drain away from any electrical component. The drain line must be directed downwards from the exhaust of the safety valve to ensure complete drainage by gravity. The diameter of the drainpipe must not be less than that of the exhaust of the valve. The end of the conduit must not be threaded or hidden and must be protected from freezing. No valves, valves or valves shall be installed on the pipe. The installation of the safety valves is governed by the local code.

3.4.4 SYSTEM PRESSURE CONTROL AND EXPANSION TANK

Pressure control devices within the system ensure that each component operates within minimum and maximum allowable pressures and maintain minimum pressure for all normal operating temperatures. They also allow air bleeding, prevent cavitation at the pump inlet and prevent water from boiling within the system; all this is accomplished with minimal addition of new water.

The increase in boiler water volume resulting from higher temperature is stored in the expansion tank during periods of high operating temperature and is returned to the system when the temperature decreases.

The expansion tank must be able to store the required volume of boiler water during maximum design operating temperature without exceeding the maximum allowable operating pressure, and to maintain the required minimum pressure when the system is cold. Contact your installing contractor, plumbing supply house, or local plumbing inspector for assistance. The point where the expansion tank is connected should be carefully selected to avoid the possibility that normal operation of automatic check or manual valves will isolate the tank from a hot boiler or any part of the system.

The expansion tank should preferably be located on the suction or intake side of the pump.

3.4.5 WATER PRESSURE MAKEUP REGULATOR

Make-up systems must be employed as required by codes. An automatic fill valve (automatic pressure regulator) must be used with a backflow preventer as required, to maintain minimum system pressure by supplying water to make up for leakage.

A minimum pressure of 5psi (34kPa) must be maintained at all times.

A backflow prevention device that complies with local standards must be installed upstream of the pressure regulator.

3.4.6 AIR BLEEDER

The air contained in the heated water must be removed from the system to allow the proper functioning of the heating system and the boiler.

Installation of manual or automatic air vents is required to eliminate all air from the boiler and the heating distribution system.

The main air eliminator must be installed near the outlet of the boiler on the highest point of the main supply piping. It is imperative to ensure that all air possibly located in the boiler be eliminated at all time.

Regularly purge air from the pipes and beware that the heated water does not cause injury or damage.

If the boiler is located at a location higher than the heat distribution system such as a heated floor, an automatic air eliminator should be installed close to the boiler outlet.

3.4.7 THERMO-MANOMETER

It is suggested to install a temperature & pressure gauge adapted to the system parameters at the boiler outlet. This allows for a physical validation of the system's pressure if the need arises.

3.4.8 CIRCULATING PUMP

The pump capacity required is determined in relation to the capacity of the boiler installed and the type of heating distribution system on which it will be connected.

They are generally designed for an operation at a differential of temperature (Delta T₀) of 10 to 20F between the supplies and return temperature to the boiler. This differential should not exceed 50F.

Use the following equation to determine the required water flow.

$$\text{Pump flow rate} = \text{Boiler power} \div \text{Delta T} \div 500$$

- Pump flow rate is expressed in US gallons per minute or GPM.
- The Boiler output (in net BTU per hour) is the maximum amount of heat to be transferred through the heating loop to meet the heating load.
- Delta T: The boiler water temperature drop

For example, an electric boiler rated at 180KW has an output capacity of 614 160 BTU per hour. The system is designed for a temperature drop of 20°F.

$$\text{Required pump flow rate} = 614,160 \div 20 \div 500 = 61,4 \text{ GPM}$$

For example, an 180kW electric boiler has a power of 614,160 BTU/h. The system is designed for a drop-in temperature (Delta T) of 20°F.

Flow required = $614,160 \div 20 \div 500 = 61.4$ GPM

N.B. To achieve proper operation, a minimum flow must be present when a heating request is applied and the heating elements are in operation. In the table below, the column representing a differential of 50°F indicates the minimum recommended flow for each boiler output. Installation of a flow switch is not mandatory. If installed, its contact must be connected between 24V+ and W1 (operation authorization)

The following table lists the required pump flow rate in relation to the boiler capacity and Delta T.

Table 9 : Temperature rise vs flow rate (GPM)

MODEL	DELTA T°			
	10°F	20°F	30°F	40°F
VoltMax 77	52,5	26,3	17,5	13,1
VoltMax 80	54,6	27,3	18,2	13,6
VoltMax 84	57,3	28,7	19,1	14,3
VoltMax 88	60,1	30,0	20,0	15,0
VoltMax 96	65,5	32,8	21,8	16,4
VoltMax 105	71,7	35,8	23,9	17,9
VoltMax 120	81,9	40,9	27,3	20,5
VoltMax 126	86,0	43,0	28,7	21,5
VoltMax 144	98,3	49,1	32,8	24,6
VoltMax 192	131,0	65,5	43,7	32,8
VoltMax 204	139,2	69,6	46,4	34,8
VoltMax 216	147,4	73,7	49,1	36,8
VoltMax 225	153,5	76,8	51,2	38,4
VoltMax 240	163,8	81,9	54,6	40,9
VoltMax 255	174,0	87,0	58,0	43,5
VoltMax 270	184,2	92,1	61,4	46,1
VoltMax 288	196,5	98,3	65,5	49,1
VoltMax 306	208,8	104,4	69,6	52,2
VoltMax 315	215,0	107,5	71,7	53,7
VoltMax 324	221,1	110,5	73,7	55,3
VoltMax 336	229,3	114,6	76,4	57,3
VoltMax 357	243,6	121,8	81,2	60,9
VoltMax 378	257,9	129,0	86,0	64,5
VoltMax 384	262,0	131,0	87,3	65,5
VoltMax 408	278,4	139,2	92,8	69,6

*Minimum flow

3.4.9 DRAIN FAUCET

A drain valve is installed behind the unit. It allows the boiler to be emptied, to make possible the replacement of defective components.

3.4.10 STRAINER

A strainer or another component that collects sediments should be installed on systems where high particle concentration may exist. Sediments may eventually get to the elements and cause damage. The warranty does not cover damages in this case.

3.4.11 PRESSURE LOSS

The graph of pressure loss due to flow of water inside the VoltMax boiler is shown in the following figure.

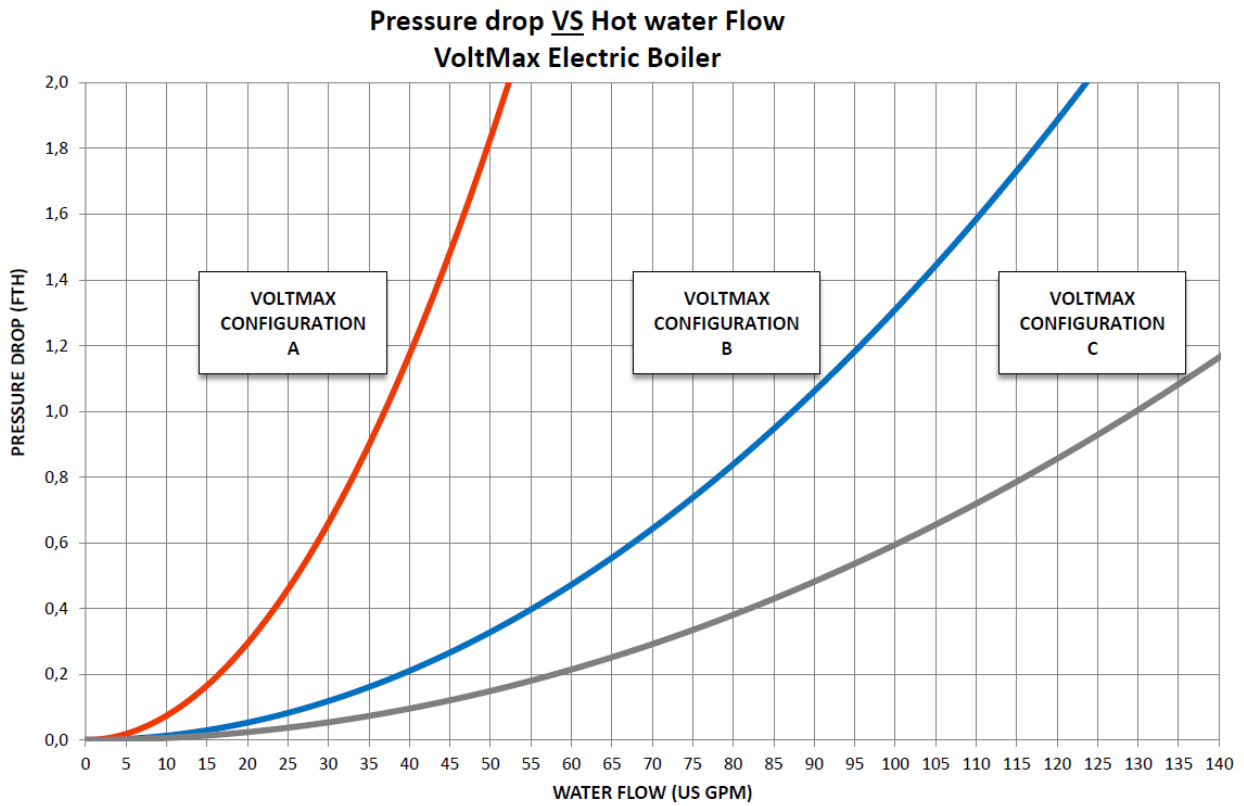

Figure 2 : Pressure loss (FTH) as a function of the flow rate of heated water (GPM)

Figure 3 : Basic installation

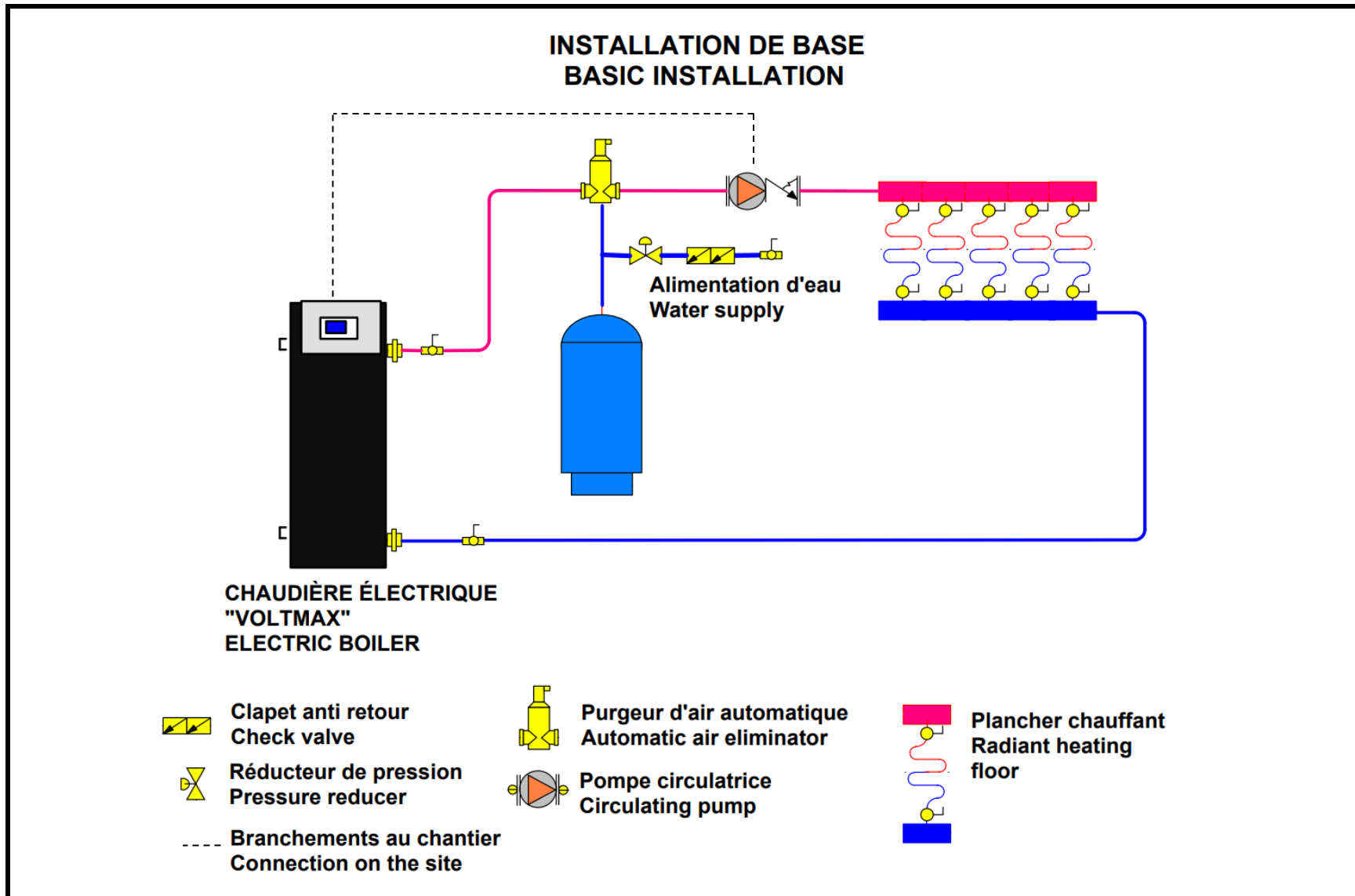

Figure 4 : Basic installation with indirect water heater and radiator

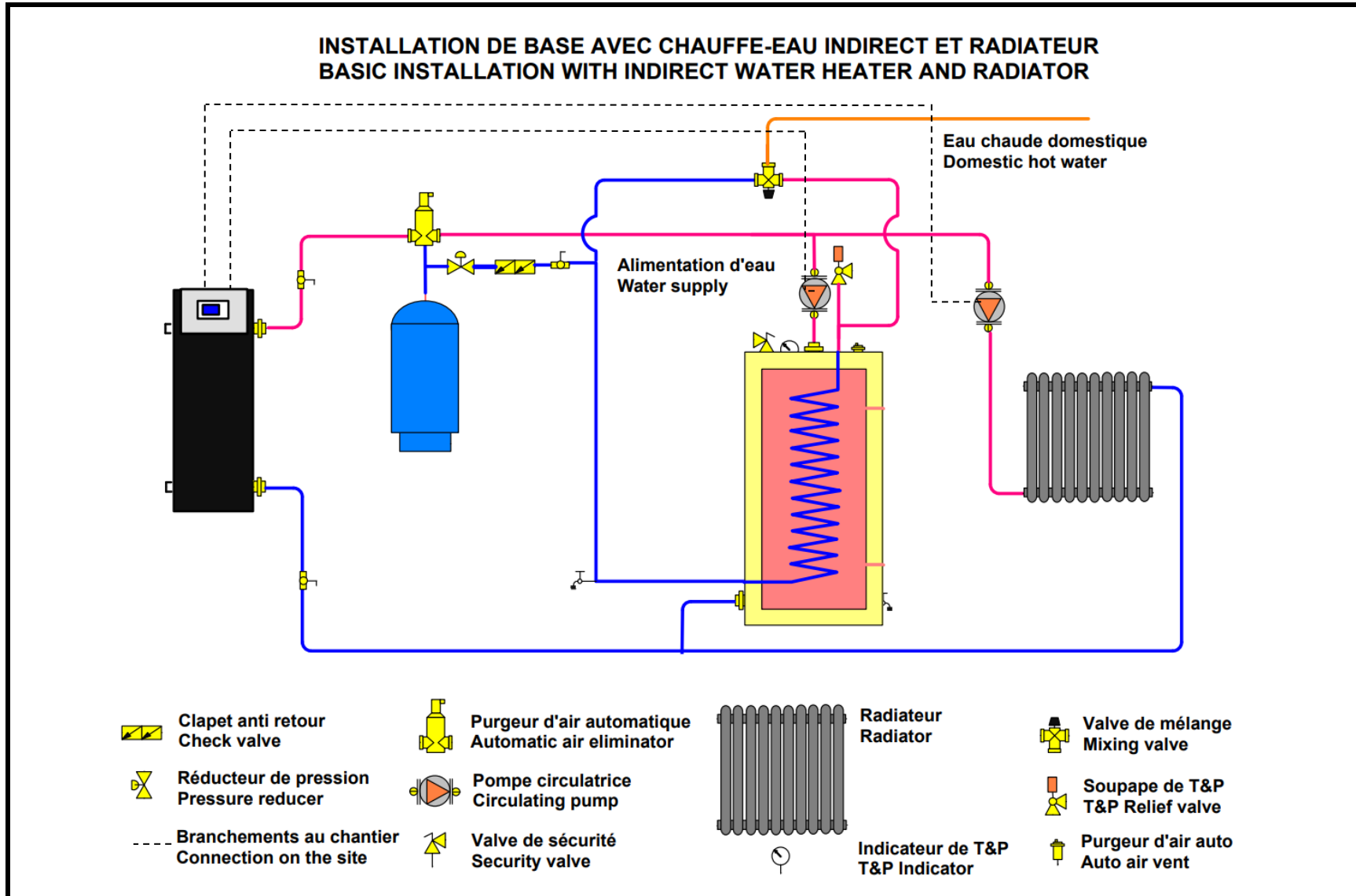

Figure 5 : Dual-Energy installation with a condensing boiler

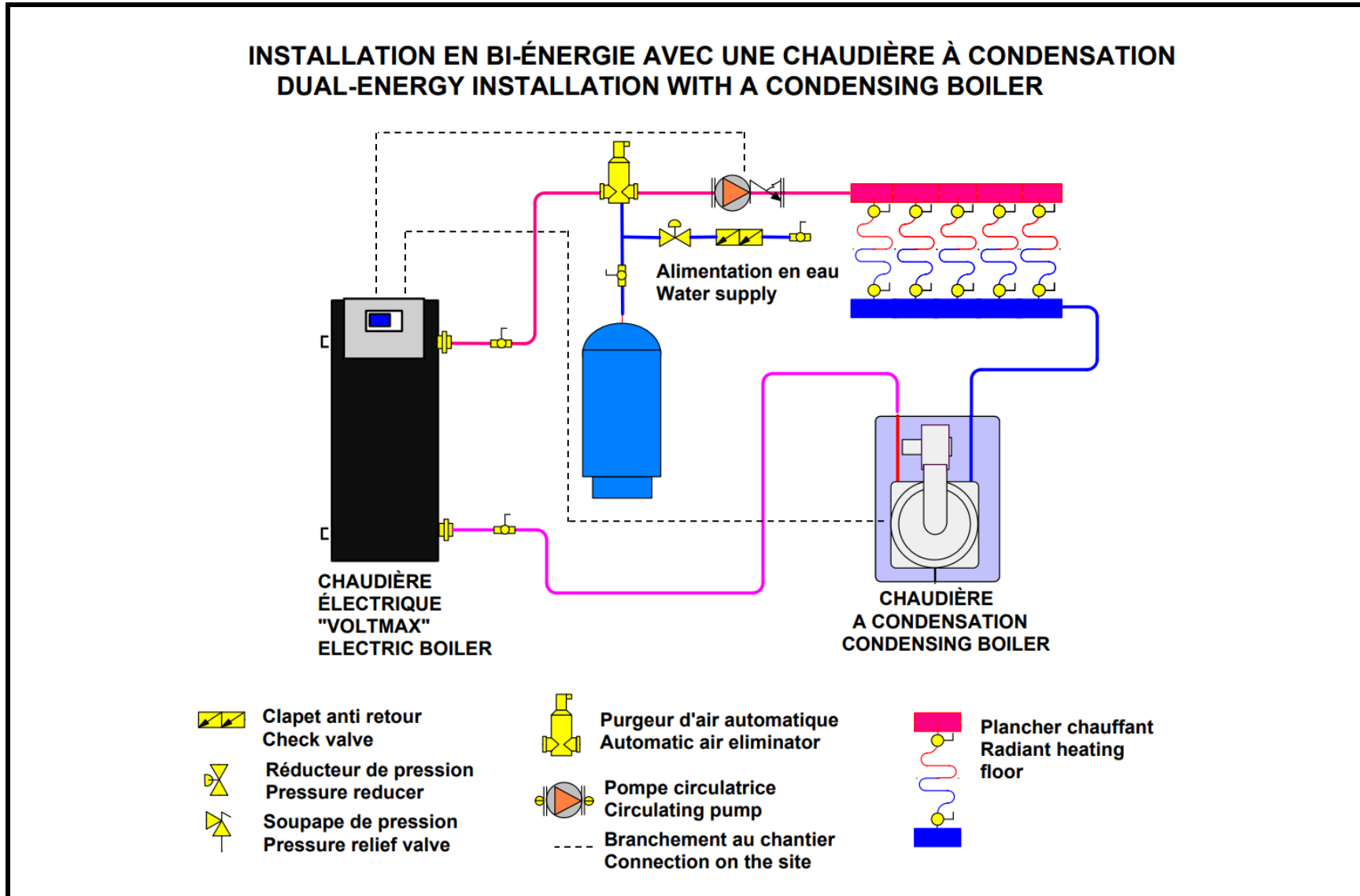

Figure 6 : Multiple boiler parallel installation

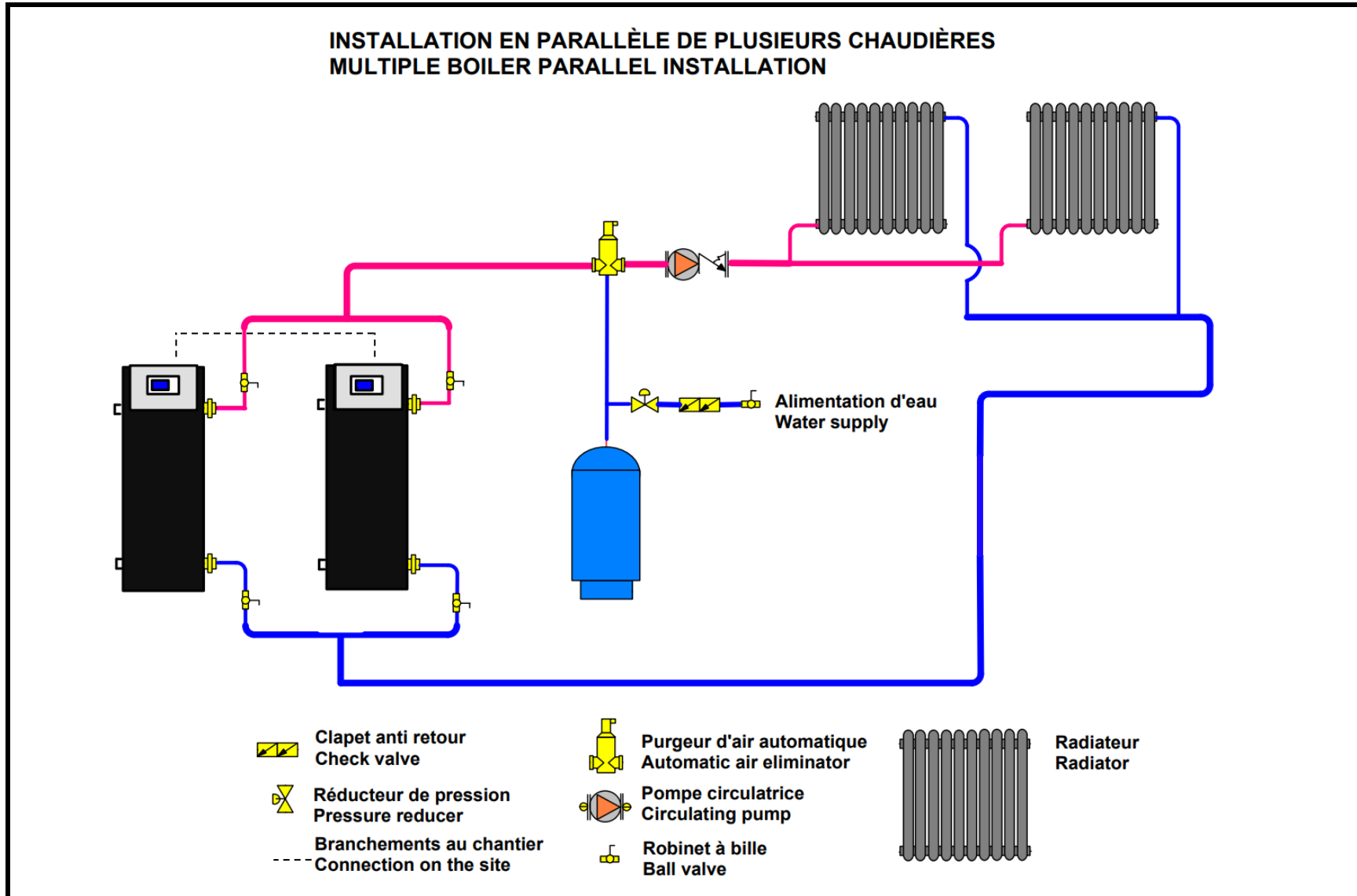
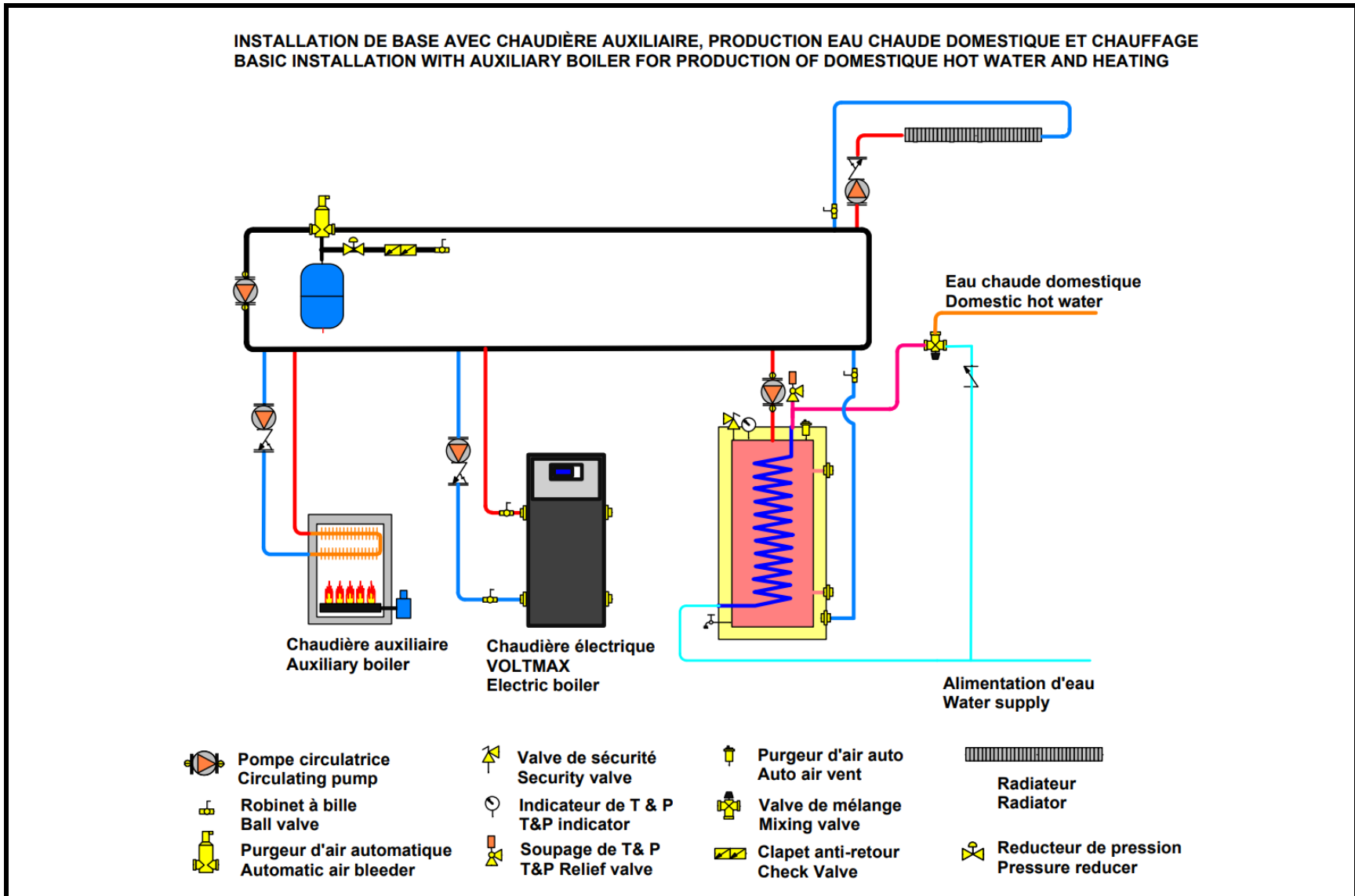

Figure 7 : Basic installation with auxiliary boiler for production of domestic hot water and heating



3.5 ELECTRICAL CONNECTIONS

Wiring must conform to the National Electrical Code and to state or local code requirements.

The electric boiler must be electrically grounded in accordance with local codes, or, in the absence of local codes, with the National Electrical Code.

3.5.1 MAIN ELECTRICAL SUPPLY

The power supply must be a 208 or 240-volt circuit (single-phase or three-phase, 60Hz), 480 volts (three-phase, 60 Hz) or 600 volts (three-phase, 60 Hz) protected by an appropriately sized breaker.

Refer to the boiler rating plate to select the breaker capacity and wiring rating

Alimentation cables can be in copper or aluminium.

The used cable gauge shall not be greater than the maximum size allowed by the connection terminals. See tables 1 through 6 for the specific values.

3.5.2 PUMP SUPPLY

The boiler controller can control one or two pumps only on boiler models that are in configuration A or B. Configuration C does not offer the possibility to control a pump.

On boiler with configuration A and B, the **Pc** to **P1** and **Pc** to **P2** contacts are used to activate an external relay (maximum 3 amps.) when there is a heat demand coming to **W1** and **W2** respectively. It is possible to give priority to pump P2 when W2 is configured to domestic hot water.

N.B. The VoltMax boiler is not designed to heat without a water circulation in its tank. Therefore, if external pump controls are used, they must be interlocked with the operating authorization on W1 and/or W2 of the controller.

3.5.3 CONNECTION OF EXTERNAL SIGNALS TO THE CONTROLLER

The connection of all external signals is made directly on the boiler controller on terminals located on top of it. See the connection diagram on Figure 8

Cables used for the connections shall resist temperature up to 90 °C.

3.5.3.1 Connecting the building heat demand signal or running authorization

Upon reception of a closed contact connected to terminals **24V+** and **W1** or **W2**, the corresponding circulating pump P1 or P2 will start and the boiler will be allowed to operate.

If external controllers control the heating system pumps, they must provide the operating authorization signal. The boiler must not receive a heat demand without the circulation pumps running.

On heating systems when water circulation is continuous, the heat demand control can be connected in series with the pumps interlocks to the **24V+** and **W1** terminals. The heating elements will then be active and available only when there is a request (dry contact).

If the heating system is designed to keep water warm with continuous circulation, a dry contact from the pumps relay or a contact from a flow sensor must be connected on the **24V+** and **W1** terminals to maintain the boiler in demand as long as the pumps are in function. The boiler will then attempt to maintain the water temperature at the set-point.

Operation with an upper fixed set-point W2 can be established by connecting the auxiliary heating demand signal (Dry contact) of a thermostat to the **24V+** and **W2** of the terminal block.

In all operating modes of the controller, a heat demand on W1 and W2/DHW (close contact) must be present to DI1 or DI2 to allow the operation of the boiler. The only exception is in domestic hot water mode (DHW) with an indirect water heater where the minimum boiler temperature shall be maintained.

3.5.3.2 Connecting an auxiliary boiler

The boiler controller is designed to allow the operation of a second boiler or an auxiliary boiler according to two different mode of operation "Auxiliary Backup" or Dual-Energy".

To do so, connect the TT terminals of the auxiliary boiler to terminals **AUX** of the VoltMax. The maximum capacity of this contact is 3A/120Vac. See section 4.3.5 for details.

3.5.3.3 Connection of an “Unoccupied signal” of the building.

This function allows dropping the boiler temperature during periods where the building is not used and this without having to lower all the room thermostats of the building.

To do so, a signal (dry contact) will have to be connected to terminal **OCC**. The contact shall be close during the periods of temperature drop.

You can also manage the periods of temperature drop by setting a schedule in the controller.

3.5.3.4 Connection of an indirect domestic hot water heater

The VoltMax electric boiler can be used not only to fill the heating requirements of the building but also to fill its domestic hot water needs using an indirect domestic hot water heater such as our TURBOMAX series.

To do so, connect the signal (dry contact) of indirect water heater temperature control to the terminal **24V+** and **W2/DHW**. This will activate the circulating pump supplying the water heater (if properly installed).

3.5.3.5 Connection of a dual-energy signal

The VoltMax can be operated in a dual-energy mode with an auxiliary boiler.

To do so, connect the normally close contact of the dual energy controller to terminals **24V+** & **BI-E** to operate with the electric boiler. See **section 4.3.5.5** for more details on the sequence of operation in dual energy.

3.5.3.6 Connection of an outdoor temperature sensor

If you wish to modulate the boiler water temperature according to the outdoor temperature (Outdoor Reset, ORST) and also wish to stop the operation of the boiler when the outdoor temp. reaches a selected value, then the outdoor sensor supplied with the unit or a corresponding signal coming from the network system shall be connected with a cable of minimum gauge 20 (max 100pi) to terminals **S. Ext.** of the controller.

This probe does not need to be connected during an operation with a fixed setpoint temperature unless you want to use the Warm weather Shutdown function.

N.B. Do not install a jumper if the outside sensor is not used.

Outdoor sensor location

- Outside the building at a location that best represents the heat demand of the building (a wall facing north for most of the buildings and on a south one on buildings with large windows facing south).
- It should not be exposed to external heat sources (dryer outlet, window openings, non-insulated walls).
- It should not be installed in a location where it could be covered with snow.

3.5.3.7 Remote controller used to determine the target boiler temperature

An external controller (such as a central building energy management system) can be used to determine the boiler target temperature required for the building.

On every model this can be done by a BACnet communication.

Also, an external controller shall give a 0 to 10VDC signal connected to terminals **0-10Vdc G** & **0-10Vdc T°** of the controller.

3.5.3.8 Limit Capacity 0-10VDC

On every model this can be done by a BACnet communication.

An external controller providing a 0-10Vdc signal could be used to manage the capacity (kW) of the boiler.

Example: An application where the main electrical service supply of the building is limited or when the electricity rate is billed according to the maximum peak loads of the building. To do so, the external controller shall be connected to terminals **0-10Vdc G** & **0-10V cap**. The capacity of the boiler could be manually limited by adjusting some of the controller parameters. See **section 4.3.4** for more details.

3.5.3.9 External alarm contact

An alarm signal (dry contact) is available on the boiler to advise the user of an alarm situation. The capacity of the contact is 5A resistive/1A inductive on terminal **AL/AL**.

The dry contact between contactors AL/AL is normally open and will close in the event that any of the following conditions appears:

- A temperature high limit
- A low water level
- Électric power loss or the control switch is at OFF.
- Lockout situation

In the “ALARM” menu on the controller, the installer has the option to select the following additional signals :

- High temperature limit from HL controller
- Low level LL
- Low flow F
- Current error A
- Sensor SE

An internal audible alarm inside the controller is available on all models. Just activate it in the settings.

3.5.3.10 Connecting an external high limit (EXT.HL)

An additional high limit control (pressure, temperature, flow, water low level...) could be required in a particular application. It shall be installed outside of the unit and its contact shall be connected the EXT. HL contactor of the terminal bloc after removing the current jumper. This contact is installed in series with the internal high limits of the boiler and will stop completely the boiler and even engage a lock out if the contact persists. Consequently, this contact shall not be used to turn on the boiler. The heat demand or running authorization should be connected on W1 or W2.

Figure 8 : CONTROL CONNECTIONS TO THE VOLTMAX BOILER (CONFIGURATION A AND B)

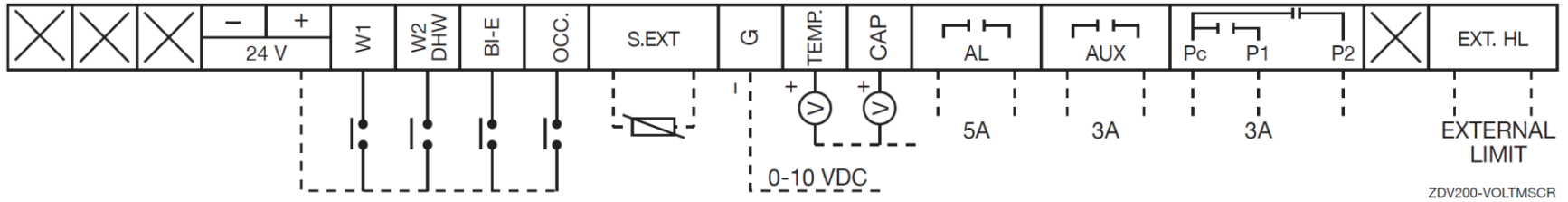

ZDV200-VOLTMSCR

Figure 9 : CONTROL CONNECTIONS TO THE VOLTMAX BOILER (CONFIGURATION C)

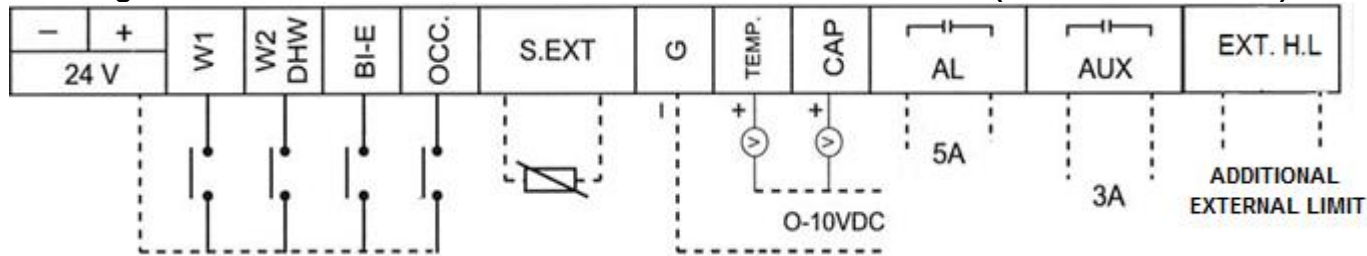
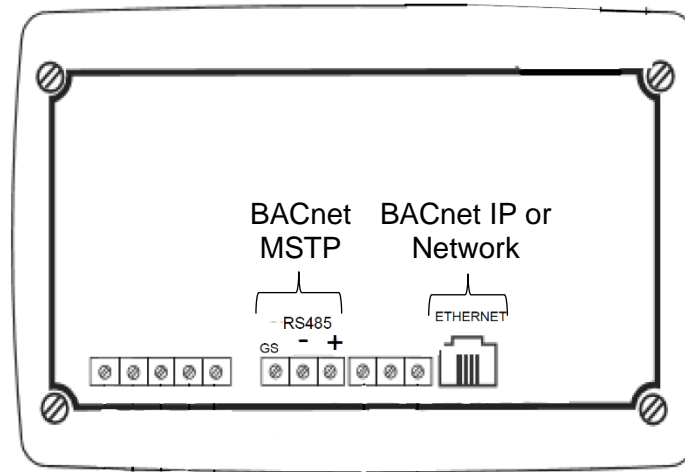

Figure 10 : COMMUNICATION CONNECTIONS (BACK OF CONTROLLER)



SECTION 4 : CONTROLLER OPERATION

4.1 USER INTERFACE

The control of the boiler is ensured by a controller TM171PFE03 from the Schneider Electric company. The LCD display of the controller provides an interface for configuring and displaying the boiler parameters and status.

A communication module also allows you to integrate the controller with an intelligent building management system (BACnet protocol). It is also equipped with an Ethernet connection. Allowing the connection to the Internet network of the building allowing reading and modifying locally or remotely the boiler setting. It can be configured to send alarm messages via e-mail.

Icons will also display to indicate the boiler's current operating status. Temperature can be displayed in Celsius or Fahrenheit and text can be set to either English or French.

The controller has a backlight function. It is also equipped with three indicator lights (Green / Yellow / Red). The green light indicates normal operation of the unit; the yellow light indicates that the controller has diagnosed an anomaly which requires verification by a technician. The red light indicates that the unit is currently in a critical state (high temperature alarm) or in lock out mode. More detail is provided in **Section 6: Troubleshooting**. The controller can also be configured to activate an internal buzzer and activate an external alarm signal **when an alarm condition occurs causing the boiler to fail**.



Figure 11 : Illustration of the display

4.1.1 SYMBOL DESCRIPTION

The main display shows most the boiler operation status information. The explanation of the main display is shown below.

Boiler operating mode

W1	Heating request 1 : On
W2	Heating request 2 : On
BIE	Boiler in Bi-Energy mode
	VoltMax Boiler : On
	Auxiliary boiler : On
	Boost mode : On
	Warm Weather Shut Down : On

Alarm symbol

	An alarm is active
	The boiler is in lock out mode
HL	High temperature limit condition at the boiler outlet
LL	Low temperature limit conditions (lack of capacity)
P	Alarm due to a pressure problem
A	Alarm due to an electrical problem
F	Alarm due to a flow problem
Se	Alarm due to a sensor problem
	The internal clock battery level is low

Operating state of the boiler

T° SET-POINT	Actual set-point temperature
T° BOILER	Water temperature at the outlet of the boiler
CAP (%)	Percentage of power used according to boiler rated power
T° EXT	Outdoor temperature measured using the outdoor sensor
KW ACT	Actual power calculated by the boiler
PRESS.	Pressure inside the boiler
STAGE	Status of active stage

4.1.2 CONTROL PANEL

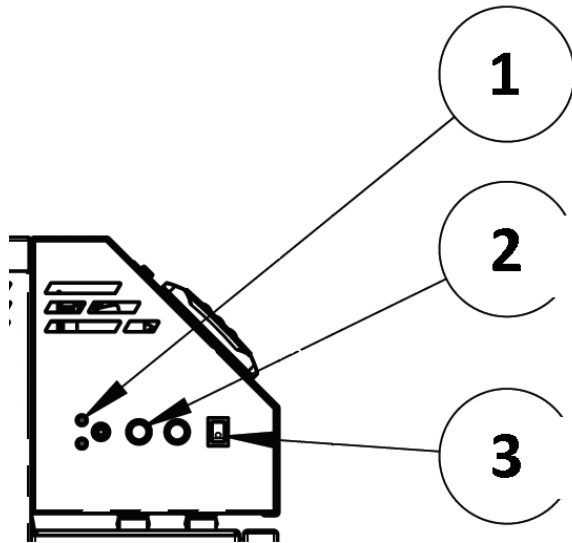

Figure 12 : Control panel

On the left side of the appliance, an on / off switch (# 3) is used to operate the appliance and to reset the boiler.

An indicator light showing the status of the low water level cut off and a test button (# 1). The control circuit fuses (# 2) are accessible from the left side of the unit.

4.1.3 NAVIGATION AND ADJUSTEMENTS

The navigation within the display is done with the five pushbuttons on the right of the screen.



Navigation between the elements is done with the **up** and **down** arrows. Use the right key to change the page in the menus. The return key will bring you to the previous menu. The return key returns you to the main display when it is pressed for 2 seconds or more.

The **OK** button confirms the selection and allows you to edit a parameter. Only highlighted box can be modified. To modify an option, select the box to modify with the arrow keys and press **OK**. The black box or one of its values will flash and can be changed. Change the values using the arrows and confirm the change by pressing **OK**.

4.1.4 MAIN MENU NAVIGATION

Press one of the 5 buttons on the main display to access the main menu

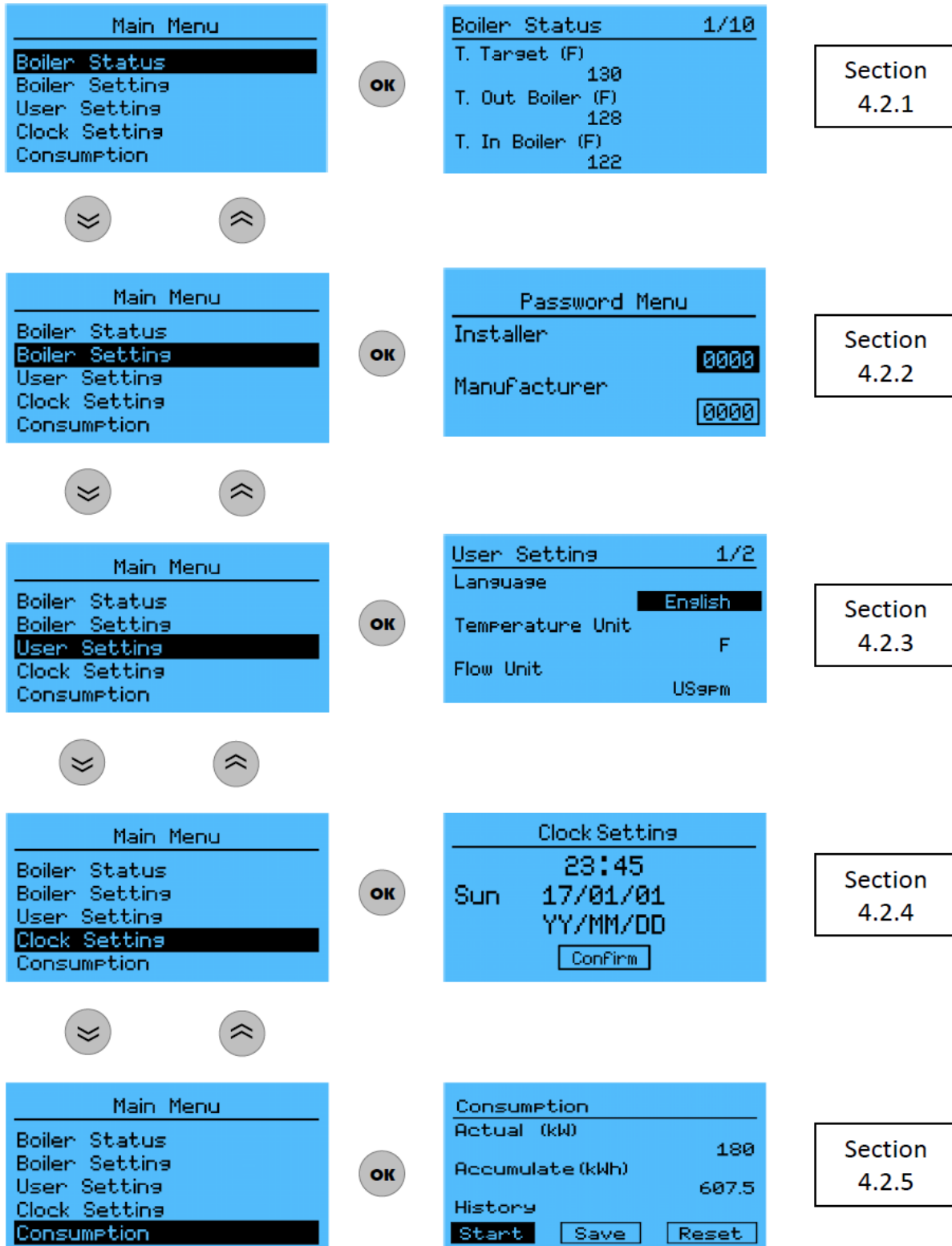
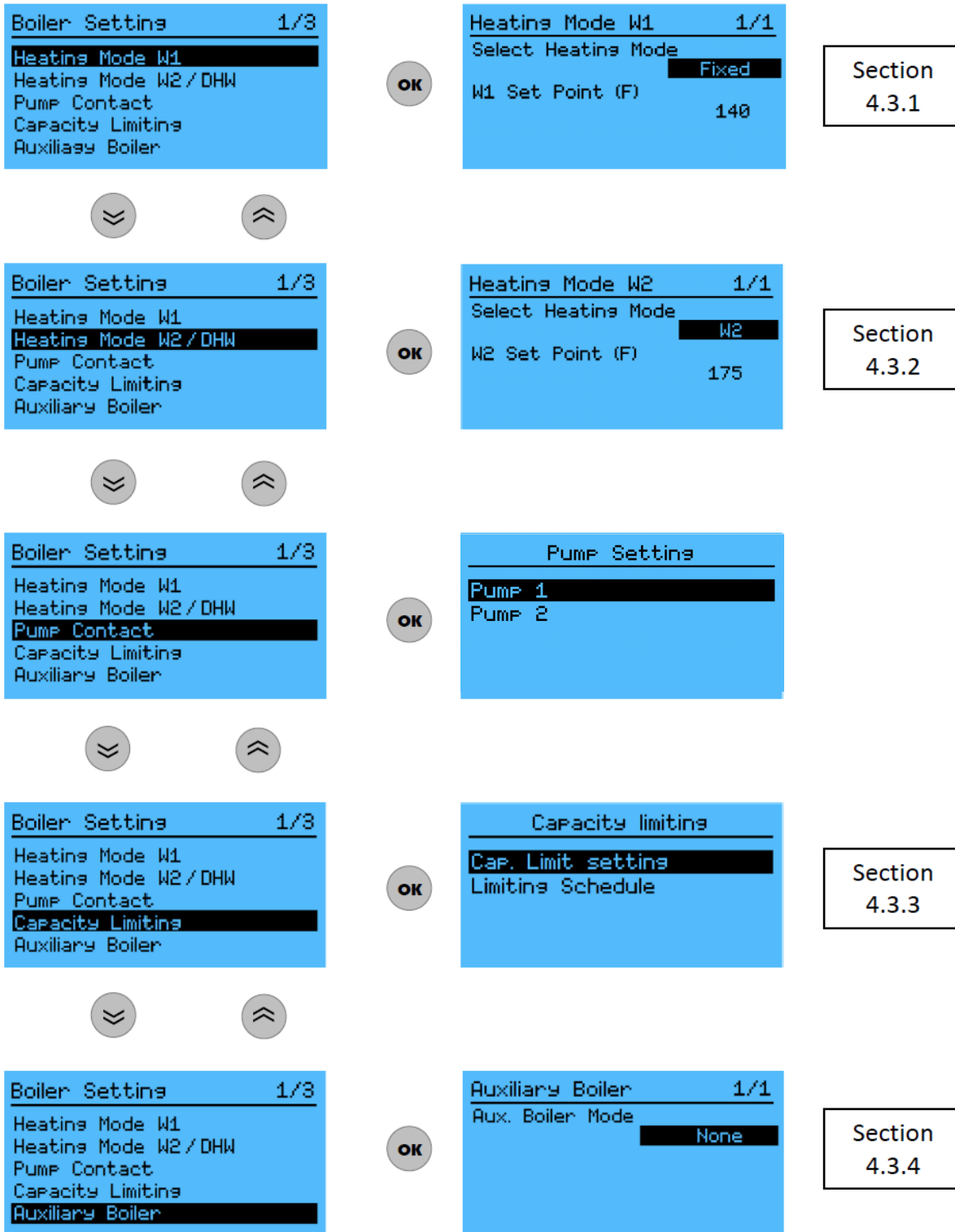

Figure 13 : Main menu navigation

4.1.5 NAVIGATION IN BOILER SETTING

Figure 14 : Navigation in boiler setting menu (1/3)



You can switch from page by using the left or right arrow (Ex : 1/3 to 2/3 by using the right arrow)

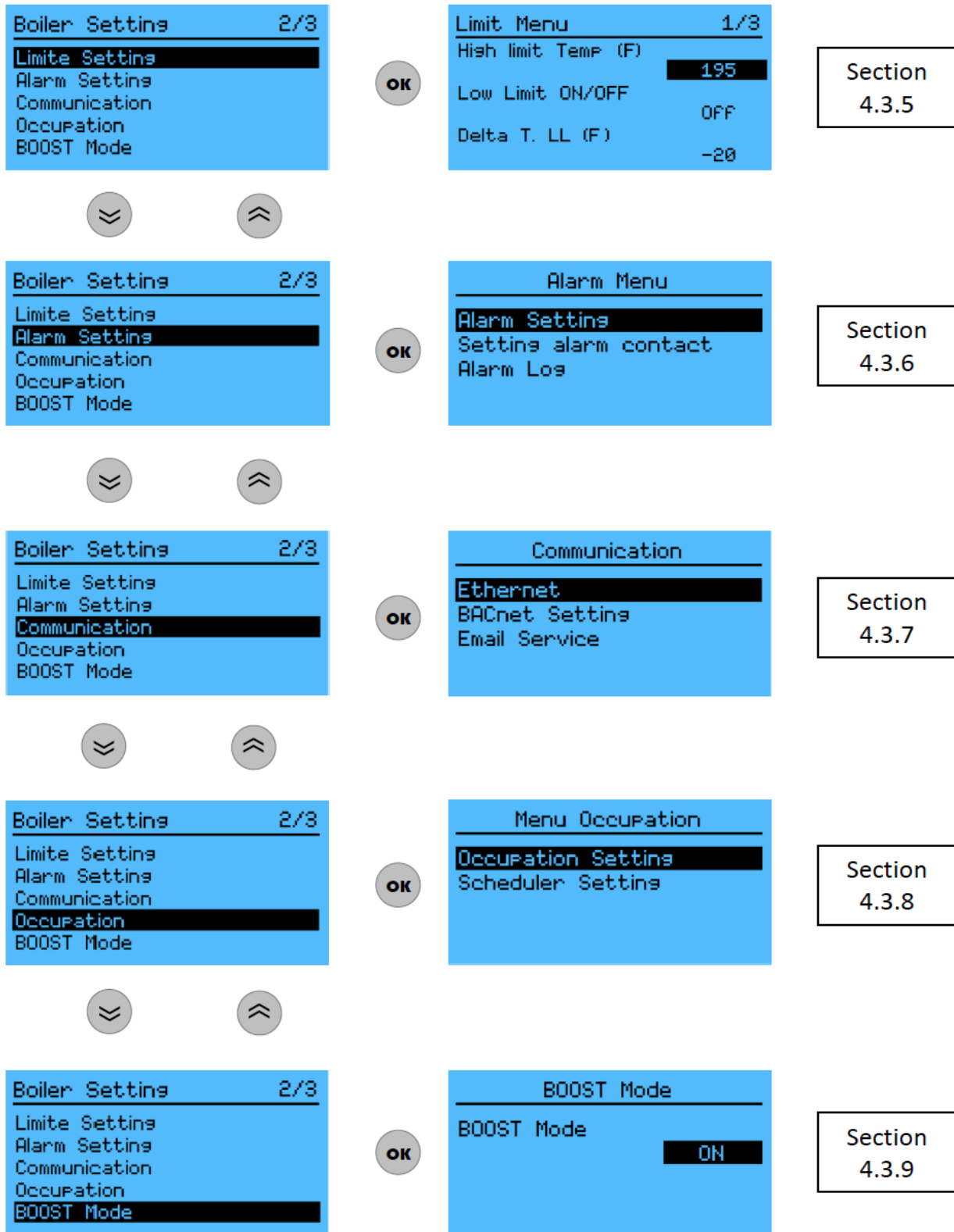

Figure 15 : Navigation in boiler setting menu (2/3)

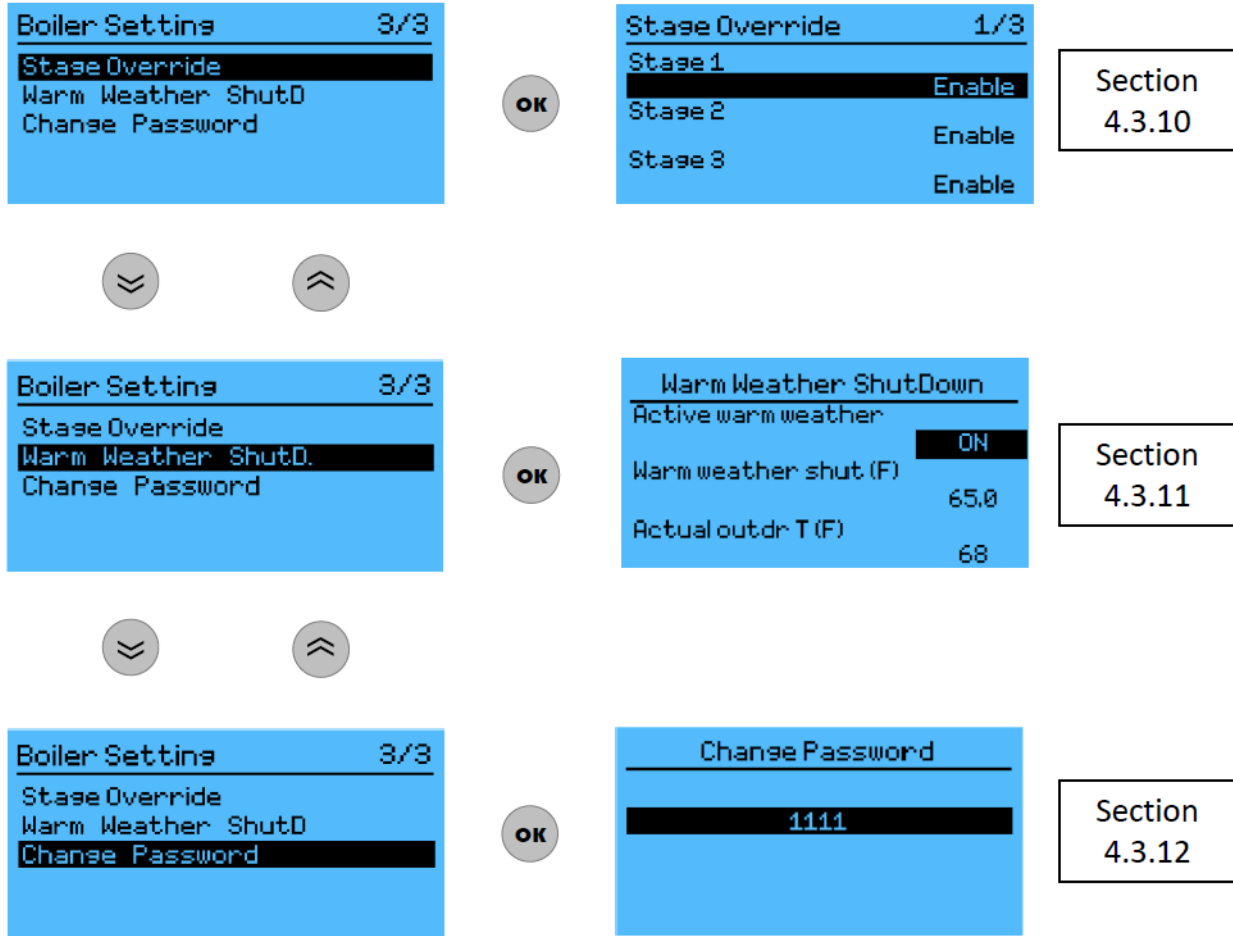
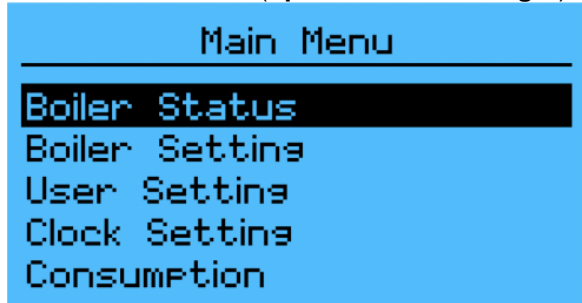

Figure 16 : Navigation in boiler setting menu (3/3)

4.2 MAIN MENU

The main menu is accessible to the user, no access code is required.

The main menu is accessed by pressing one of the 5 pushbuttons. Navigation between menus is done with the arrows (**up, down, left and right**).



Menu	Contents
Boiler status	Detailed information on the boiler condition
Boiler setting	Configuration of the boiler operating mode and parameters.
User setting	Configuration of the controller display option
Clock setting	Configuration of the internal clock
Consumption	Power consumption of the boiler

4.2.1 BOILER STATUS

Detailed information on the boiler condition

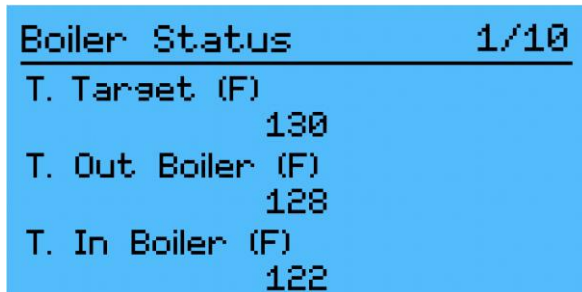

This menu allows the display of data not included in the main display. The boiler status menu displays the measurements of temperature, pressure, flow, alarm summary, version of the programme and the status of the heating element.

The set of variables presented in this menu are presented in **Section 4.5**

4.2.2 BOILER CONFIGURATION

Configuration of the boiler operating mode

This menu is accessible only to the installer or to an authorized person.

The default installator password is **1111**

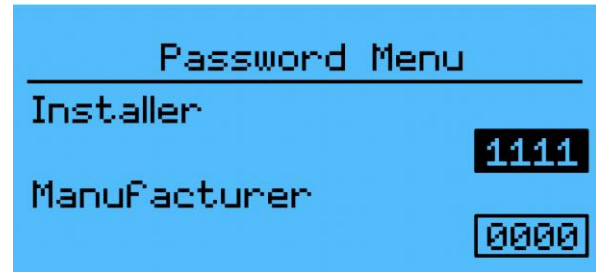

To enter the password:

- Press up or down arrows until the “installer” rectangle becomes black, then press “OK”.
- Press the up arrow once the change from 0 to 1.
- Press left arrow and the second number will be selected. Press the up arrow to change from 0 to 1
- Proceed the same way to enter the other numbers. Press OK when done.

The options in the **Boiler setting** menu are detailed in **Section 4.3**.

The **Manufacturer** access code gives access to advanced operating parameters that are not accessible to the installer and the user.

4.2.3 USER SETTING

Configuration of the controller display option

This menu allows the modification of different display parameters.

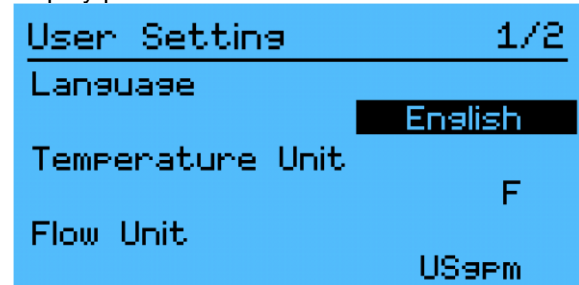

Parameters	Description
Language	Select English or French version
Temperature unit	Select the temperature units, either Celsius (C) or Fahrenheit (F)
Flow unit	Select the flow unit, either US gallons per minute (USgpm) or liters per second (L / sec)
Backlight	Setting the backlight mode: <ul style="list-style-type: none"> - Off - 30 secondes - Always On
Internal buzzer	ON/OFF setting of the internal buzzer

4.2.4 CLOCK SETTING

Internal clock configuration



Use this menu to adjust the controller's internal clock. To set the clock correctly, you must adjust the time, minutes, and date.

This adjustment is necessary in order for these modes to function properly:

- The boiler's power consumption
- Limiting the boiler's power capacity according to a schedule
- The boiler's occupation mode

Battery life for the clock is at least 1 year when the controller is unpowered (at 25°C). When the battery is low an indicator will appear on the screen. The battery shall be replaced to keep to clock active. Following a battery replacement, the internal clock must be reprogrammed to remove the indicator on the bottom of the screen.

The clock will not be updated on season changes unless connected to a network system.

4.2.5 CONSUMPTION

Boiler consumption cycle report

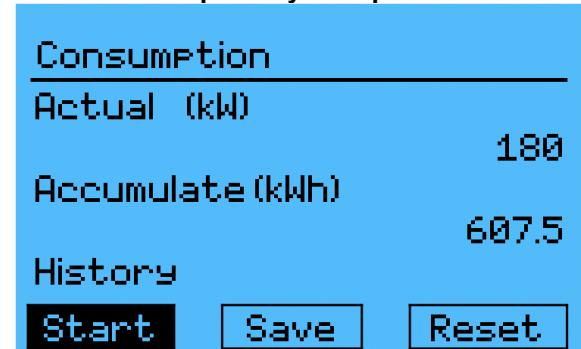

This menu allows visualization of the boiler power consumption report. First, you must activate the beginning of the consumption cycle with the **Start** key. The consumption report can be saved using the **Save** key. And all saved report is available on the **History** tab. The beginning of the consumption cycles can be reset using the **Reset** button.

The controller records up to 30 consumption report.

N.B The consumption values are approximate and should not be used as a comparison with actual consumption data charged by the electricity distributor.

4.3 BOILER SETTINGS

In order to be able to configure the boiler, it is necessary to authenticate yourself with an installer or manufacturer code.

The default "Installer" access code is **1111** and can be changed in the **Change password** menu.

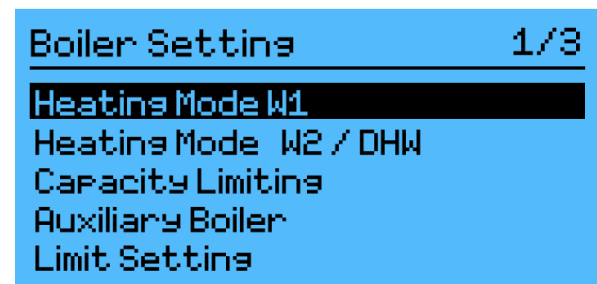

HEATING MODE W1	Boiler heating mode W1 configuration according to the type of application
HEATING MODE W2/DHW	Boiler heating mode W2 or DHW configuration according to the type of application
CAPACITY LIMITING	Capacity limiting mode configuration
AUXILIARY BOILER	Auxiliary boiler mode configuration (if needed)
LIMIT SETTING	Configuration of the boiler operating limits

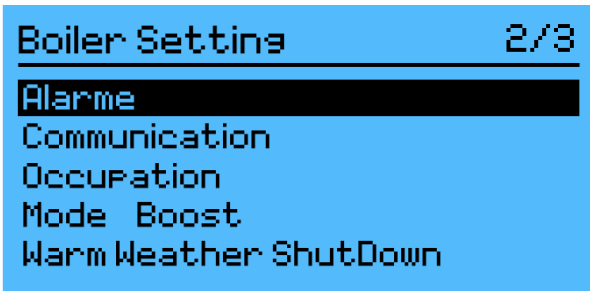

ALARM	Configuration of the alarms
COMMUNICATION	Configuration of the boiler communication parameters (Web, Email, Bacnet)
OCCUPATION	Configuration of the occupation parameter mode
MODE BOOST	Enable Boost mode
WARM WEATHER SHUTD.	Enable warm weather shut-down function



CHANGE PASSWORD	Changing the Installer password
------------------------	--

4.3.1 HEATING MODE W1 Selection of the operating mode

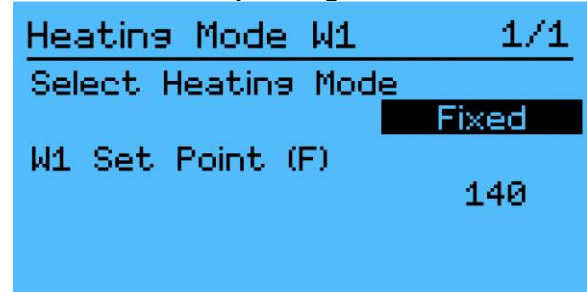

In this menu you must select an operating mode for selecting the desired setpoint temperature depending on the application. A heat demand or a demand must be present on W1 and/or W2/DHW so that the boiler can heat up. Otherwise the boiler will indicate “---”

During a heat demand, the boiler activates (depending on a PID curve) the number of stages required in sequence so that the boiler output temperature is maintained at the approximate set-point temperature.

Here is the list of W1 heating modes:

FIXED	Fixed boiler set-point
DDC 0-10 VDC	Modulation of the boiler set-point using a 0-10VDC signal
OUTD RESET	Modulation of the boiler set-point using the outdoor temperature
STOP	No heating demand on W1

4.3.1.1 Fixe

This mode is used for an installation where it is desired to have a fixed set-point temperature. If the boiler is thermostat-controlled with a heat demand signal on W1, the boiler uses the corresponding set-point (**T. Set-point W1**) as the supply temperature.

4.3.1.2 DDC 0-10 VDC

This operating mode allows modulating the boiler set-point temperature according to a 0-10VDC signal applied the terminal **0-10VDC** and bornier **0-10Vdc G** et **0-10Vdc T**, produced by an external controller (Ex: Building Energy Management Controller).

The details of the parameters in this mode are presented in **Section 4.6.3**.

4.3.1.3 Outdoor reset

This operating mode makes it possible to modulate the boiler output set-point temperature as a function of the outdoor temperature. The outdoor temperature signal comes from the temperature sensor supplied with the boiler, which will be connected to the boiler controller.

The details of the parameters are presented in **Section 4.6.2.**

4.3.1.4 Stop

Select this mode to stop the boiler. The heating elements will not operate on a W1 demand.

4.3.2 HEATING MODE W2/DHW

This mode allows you to configure a second heating demand (W2) or a demand from an indirect domestic water heater (DHW). Select **none** if none of these functions are used. These modes are presented in detail in Section 4.7 .

W2

This mode allows the W2-DHW input to be used to receive a signal (dry contact) from a 2nd stage of heating. When the contact on W2-DHW closes, the set-point temperature changes to the set value (**T. Set-point W2**), even if there is no demand on W1.

DHW

This mode allows you to configure the demand for an indirect domestic water heater. When the DHW mode is selected, the boiler is kept at a minimum temperature (**T. Min Boiler**) and when contact W2 closes (Dry contact) the set-point rises to **T. DHW Set-point**. In addition, the PID curve is more aggressive.

4.3.3 PUMP SETTING

Configuring pump contact activation (Available only configurations A and B)

The system allows the control of up to two pumps. Each of these pumps can be activated using a contact. Each pump can be activated according to different modes.

If the amperage of each of the pumps exceeds **3A**, external pump relays must be used.

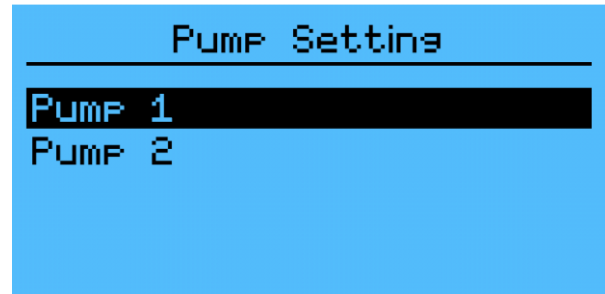

Pump Configuration Options

On W1 Dem.	Contact of pump 1 is activated only when there is a demand on W1.
On W2 Dem.	Contact of pump 2 is activated only when there is a demand in W2.
Priority over P1	When there is a request on W2, contact of pump 2 is activated and contact of pump 1 is deactivated.
Always On	The selected pump is always on (contact is always on).
Stop	The selected pump is always deactivated (contact is always off).
Off Delay	The delay in seconds before the contact of the pump is deactivated.

N.B. External pump relays can also be used as an alternative to the boiler pump controller. If this alternative is used, a dry contact of this controller must be connected to W1 or / and W2 to allow the boiler to operate only when there is a flow of water present.

4.3.4 CAPACITY LIMITING

Adjusting the maximum authorized power

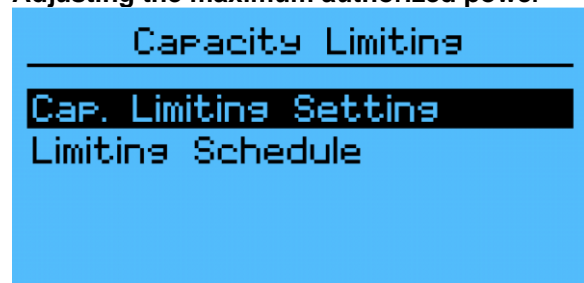

This menu allows you to configure the boiler output limit. The selection of the limit mode can be selected in the **Capacity limiting** menu

- None
- Manual
- DDC 0-10 VDC
- T. Ext
- Schedule

Details of each of these options are presented in **Section 4.8**.

N.B: It is not recommended to disconnect one of the power relays inside the VoltMax boiler to accomplish this function.

4.3.4.1 None

The boiler is not limited in power, the maximum power it can deliver is equivalent to its maximum rated power.

4.3.4.2 Manual

The maximum capacity permitted of the boiler is configured in a fixed mode.

Details of the variables in this mode are presented in **Section 4.8.1**

4.3.4.3 DCC 0-10 VDC

A 0-10 VDC signal from a building management system can be used. The signal is treated as a function in order to limit the maximum power. In order to configure this mode, you must connect the 0-10 VDC signal to the terminal block **0-10Vdc Cap.** and **0-10Vdc G.**

Details of the variables in this mode are presented in **Section 4.8.2**

4.3.4.4 T. ext

The maximum permitted power can be adjusted according to the outside temperature sensor. The outdoor temperature is used in order to limit the maximum authorized power.

Details of the variables in this mode are presented in **Section 4.8.3**.

This mode of operation is particularly advantageous in applications where the boiler is connected to an electrical network taking account of demand peaks in order to determine the cost of use (demand meter). Since the boiler will thus be limited to a maximum power which will have to be established as a function of the heating requirements of the building and the outside

temperature, it will thus be possible to avoid peaks of power not required to satisfy the heating needs in periods of cold weather.

4.3.4.5 Schedule

The maximum authorized boiler power can be programmed according to a schedule. See **section 4.8.4** for an explanation of how to modify a schedule.

4.3.5 AUXILIARY BOILER

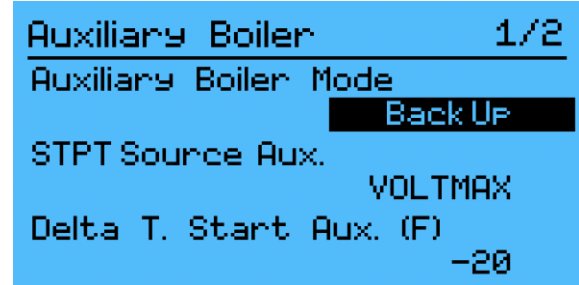

The controller program has been designed to allow the operation of a second boiler or auxiliary boiler.

4.3.5.1 Select setpoint source for Auxiliary Boiler

The source of the set-point temperature control can be configured by selecting **STPT source Aux.** consequently.

In the **VoltMax** mode, the terminal contact **Aux** closes when there is a request for W1 or W2/DHW and the VoltMax output temperature is below the setpoint temperature. In addition, the Aux contact is opened when the output temperature is higher than the setpoint temperature.

In **AUXILIARY** mode, the Aux contact closes when there is a request on W1 or W2 / DHW regardless of the boiler output temperature VoltMax. The VoltMax boiler thus has no set temperature and is only used to activate the auxiliary boiler relay. The various configurations of the **Aux boiler** mode are the following:

None	No auxiliary boiler is present
Backup Aux.	This mode allows the adjustment of a second boiler to play a Backup role
Ext Contact	Select the heating source using external contact to the BI-E terminal.
BiE (BI-Energy)	Select the heating source using external contact to the BI-E terminal with the possibility of support mode of the auxiliary boiler.
Manual	Manually select the system operation mode (Electrical or Auxiliary).

N.B. The auxiliary boiler can only be switched on when a heat demand is present on W1 or / and W2 / DHW.

4.3.5.2 None

This mode must be active when there is no auxiliary boiler on the hydronic heating system.

4.3.5.3 Backup Aux.

The boiler will be activated according to the configuration of the lack of capacity of the VoltMax boiler.

In the event of a lack of capacity, the boiler is started to compensate.

The lack of capacity is defined by the fact that the boiler output temperature is less than X degrees (**Delta T. Start Aux.**) relative to the set-point for duration of X min. (**Auxiliary Start Delay**). The auxiliary boiler will be deactivated when the temperature differential between the water outlet temperature and the set-point temperature is lower than **Delta T. Off Aux.** The calculation of the delay begins only when the electric boiler reaches its maximum power (or maximum power allowed).

The value of "Delta T." should be a negative value.

Details of the variables in this mode are presented in **Section 4.9.1**

4.3.5.4 Contact Ext.

This configuration mode makes it possible to operate the electric boiler or the auxiliary boiler according to a contact. During a close contact at the **BI-E** terminals, the electric boiler (⚡) is activated. When the contact is open, the auxiliary boiler (🔥) will be on. The auxiliary boiler will not

be allowed to operate if the electric boiler lacks capacity.

Details of the variables in this mode are presented in **Section 4.9.2**

4.3.5.5 BiE (BI-Energy)

The Bi-Energy mode allows the auxiliary boiler to operate when there is a lack of capacity.

Upon receipt of an electrical signal (contact closed at **Bi-E**) and a request at the terminal of **W1** or **W2**, the contact at the terminal of **AUX** will be opened and thus the electric boiler (⚡) is allowed to operate and the auxiliary boiler is deactivated.

When an electrical signal is absent (contact open at **Bi-E**) and a request is present at the terminals of **W1** or **W2**, the contact will close at the terminal of **AUX**, in order to operate the boiler Auxiliary (🔥) and not the electric boiler.

If the electric boiler is turned off (lock out), the contact on the AUX contactor will close to authorize operation of the auxiliary boiler.

4.3.5.6 Manual

Manual mode is used to manually select the operating mode of the system (Electrical or Auxiliary).

Details of the variables in this mode are presented in **Section 4.9.3**

4.3.6 LIMIT SETTING

Configuring the boiler operating limits

Use this menu to adjust the permissible operating boiler limits for various parameters. This menu also offers the possibility to activate or deactivate the pressure and current sensors depending on the needs.

Limit Setting	1/3
High Limit Temp. (F)	195
Delta T. LL (F)	-20
Delay LL (min)	60



This menu's configuration options are presented in detail in **Section 4.11**.

4.3.7 ALARM

Alarm Mode Configuration

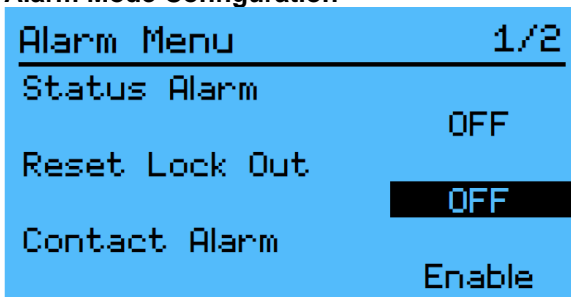

When an alarm is active, it will be displayed on the main display as a symbol.

	An alarm is active
	The boiler is in lock mode
HL	The high limit temperature has been reached
LL	Low limit (Lack of capacity)
P	Pressure problem alarm
A	Electrical problem alarm
F	Flow problem alarm
Se	Sensor problem alarm
	The internal clock battery level is low

A summary of active alarms is also available in the **Boiler status** menu.

Section 6 - Troubleshooting details alarm codes and settings specific to this menu.

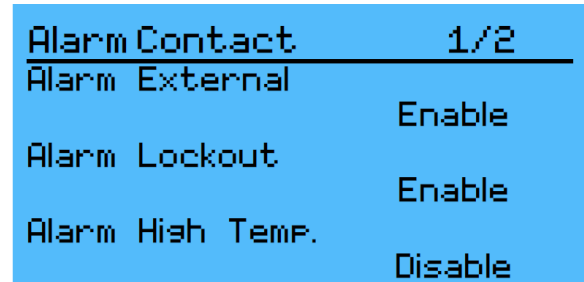

On the SCR models. The alarm contact between AL/AL can be configured in this menu with the following conditions:

HL/LL/P/A/F/SE

This contact can not be deactivated (except silence button) when in low water level or HL condition.

An alarm report is available under the **Alarm log** menu. Information about date, time and alarm code is available in this menu. The internal clock must be adjusted beforehand so that the alarm registers correctly.

Details about this menu's operation are available in **Section 4.10**

4.3.8 COMMUNICATION

The boiler controller can be connected by an ethernet connexion port or by RS485 (BACnet SMTP). The boilers web portal can be accessed by different means. It is then possible to modify parameters from distance on this web portal and to visualize the functioning status of the boiler.

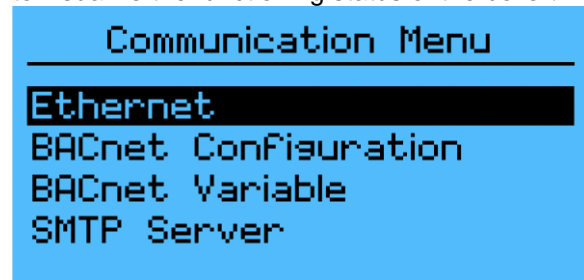

4.3.8.1 IP Address

This menu permits to configure the connection properties of the VoltMax boiler.

Direct connection between the controller and a computer (Direct Ethernet cable).

1. Connect the boiler controller on the local network with the ethernet port (On the back of the controller) with a standard RJ45 cable. See electric diagrams if needed.
2. On your computer, open a command window (On windows operating systems, type « cmd » in the program search bar).
3. In this command window, type « ipconfig » and write down your IPv4, subnet mask, and default gateway (as shown on the next figure).
4. Back on the controller, in the Communication/Ethernet section change the default IP address (10.0.0.100) Local for an address that is compatible with the one that got written down. The last 3 numbers should be different than your IP address (make sure not to use an already existing address). For example, the IP address 192.168.0.232 could have been used in this particular case.
5. In the same section, enter the written down default gateway and subnet mask. DNS servers may be left as default (8.8.8.8 and 8.8.4.4).
6. Reboot the controller to apply all changes.
7. On a web browser, you may now directly write the chosen IP address in the navigation bar (as if it was a website) and you will be redirected to the controller's webpage. By the default, the username and password are as given in the next table.

By default

Username	administrator
Password	password

Distant wireless connexion with a WI-FI router.

If the boiler cannot be directly connected to the network, a WI-FI router may be added to it to act as connection between the boiler and the network. Connection procedure may vary from one router to another. This example is for a tested TP-LINK TL-WR802N router.

1. Modify all the IP parameters as show in the last section so the controller is compatible with the network.
2. Connect the power to the router
3. Connect the network cable to the router in the LAN/WAN port and to the ethernet port on the controller.
4. Use a computer to connect to the temporary network of the router.
5. Open a web browser and go to the <http://tplinkwifi.net> web page or to the default router address.
6. Follow the instructions in the router manual to set it up as client mode.

7. The client mode will connect the controller to the WI-FI network and the boiler will then be accessible as same as the direct connection method.
8. The boiler can be accessible from distance with a VPN if the computer is not connected to the local network.

By default

Router address	192.168.0.1
Username	admin
Password	admin

9. Reboot the controller to apply all changes.

4.3.9 CONFIG. BACNET

The control of the boiler by an external BACnet controller can be activated or deactivated by selecting "local" or "BACnet"

The Config. BACnet menu allows you to view the configuration and change the BACnet parameters to establish the BACnet communication.

In order to configure the VoltMax boiler to your BACnet management system, you must activate the function.

The controller allows a BACnet IP or MSTP communication.

You must then enter the;

- **SOURCE.** Can be selected as "LOCAL" to control the boiler with its controller or as "BACnet" to control the operation parameters with an external controller. This selection has to be made on the selector switch located on the left hand side of the control panel.
- **DEVICE INSTANCE.** To be adjusted with the client BACnet equipment
- **MAC ID address.** By default for a BACnet MS / TP communication with a *Metasys* system, the address is 5.
- **BACNET MS/TP ou IP**
- **BAUDRATE.** For a BACnet MS / TP communication protocol with a *Metasys* system the default baud rate is 38400.
- **Device instance.** To be adjusted with the client BACnet equipment.
- If required the following informations can also be modified to adapt to the client controller.
DATA BIT : / PARITY /STOP BIT
- Following this, determine if the command signals W1/W2/OCCUPATIO/BI-ENERGY will be coming from local contacts (signals connected to the terminal bloc of the control boiler panel) or from the BACNET controller.

The names of the BACnet variables used by the program are listed in the tables 4.5 through 4.15 below. **Variables beginning with AV and BV are read variables, while variables beginning with "W" are editable.**

For more information on the BACnet protocol, please refer to the appropriate documentation.

4.3.10 OCCUPATION

Setting the temperature-lowering period.

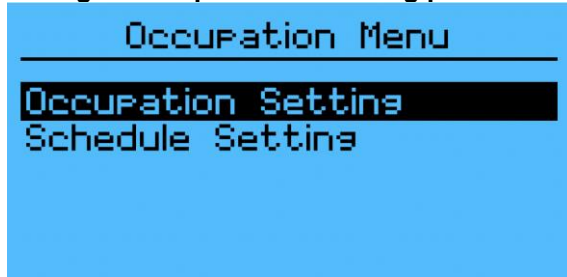

4.3.10.1 Occupation setting

This function allows the boiler water temperature to be lowered for defined periods without having to lower all the thermostats of the building. This function can be activated and deactivated within the menu **Occupation** under **Occupation mode**. This function allows the set-point temperature to be lowered when the boiler is within the hours specified in the **Schedule Setting** menu. The temperature drop (the value should be negative) in the set-point can be changed in the **Occupation Setting** menu.

The **SCR model** allows the connection of a contact (OCC Contact) allowing the use of an external timer to control the **OCCUPATION** function.

Ex: When the contact (switch) is open at the OCC terminal, then the boiler will be in temperature-lowering mode. (Night mode) When the contact (switch) is closed, it will be in normal occupancy mode (Day mode).

Force is used to force the boiler to operate normally (day mode).

A weekly schedule can be programmed under the **Schedule setting** to modify the occupation hours of the building.

N.B: The internal clock of the controller does not take in account the daylight-saving time changes.

4.3.10.2 Schedule Configuration Changing a Schedule

Use this menu to configure the building's occupation schedule. The schedule works on a weekly schedule (Monday - Sunday) and allow only 1 lowering Set point periods. The first hour represents the start of the occupancy period and the second hour represents the innoccupancy periods.

Schedule	Start	Stop
Mon	07:00	18:00
Tue	07:00	18:00
Wed	07:00	18:00
Thu	07:00	18:00
Fri	07:00	18:00
Sat	00:00	00:00
Sun	00:00	00:00

Ex: In the case currently displayed between 07:00 and 17:59, the set-point temperature will not be affected. On the other hand, from 18:00 to 06:59, the set temperature will be lowered.

When the building is not occupied for a full day, you must enter this information as follows, so that the stpt stay in the lowering mode.

Sun 00:00 00:00

4.3.11 BOOST MODE

Enable Boost Mode



This mode operates with the **Fixed Set-point** and **Outdoor reset mode**.

This menu allows the Boost mode to be activated, this mode increase the set-point temperature when the heating load of the building exceeds the capacity generated by the current water temperature determined by the boiler.

This mode is activated after a period of 30 min if the heat demand is maintained for 30 consecutive minutes on W1. After this period, the set temperature will start to rise until a predetermined maximum temperature is reached depending on the heating mode until the demand is filled. This temperature increase is temporary and has a maximum duration of 120 minutes or when the request is terminated on W1.

N.B. The **BOOST** mode is particularly interesting for applications such as:

- Applications with a programmable thermostat with automatic lowering of the building temperature.
- Return to normal heat demand after a prolonged period of sunshine where there have been no long-term demands and, therefore, heating floors will take a long time to provide heat at d Normal water.

4.3.12 STAGE OVERRIDE

Stage Override	1/3
Stage 1	Enable
Stage 2	Enable
Stage 3	Enable

This mode permits to temporarily override defective stages in the boiler that require non-urgent repairs (i.e. Burnt element, buzzing contactor, etc.). If a stage is overridden, a current alarm will be displayed until this stage is not re-enabled.

4.3.13 WARM WEATHER SHUTDOWN

Shuts down the boiler when the outside temperature reaches an established threshold.

Warm Weather ShutD.	1/1
Active Warm Weather	ON
Warm Weather Shut T.	68
Actual Outdoor T. (F)	56

This mode stops the boiler's heating production when the outside temperature is higher than a pre-determined temperature (ex: 68°F).

Note: If the boiler is configured with DHW mode, it will continue to operate normally in order to meet the DHW heating demand.

4.3.14 CHANGE PASSWORD

Changing the password

This menu allows you to change the installer account password

4.4 ETHERNET

The settings available on the controller are also available remotely on a web portal. This portal works only when the boiler is properly connected to an internet or Ethernet network. The various setting parameters and the protocol for connecting the boiler to a network are available in the **Communication menu** and **Section 4.3.8**.

4.4.1 WEB PORTAL

In order to access the boiler remotely via the internet, the boiler controller must be correctly connected.

The web portal has 3 main menus, the **User**, **Installer** and **Manufacturer** menu. The structure of the web portal is the same as the controller; please refer to the previous sections, if you have any questions.



Ex: The user can obtain information concerning the boiler status, in the menu Operations /

N.B. The password to access the installer section of the website is 1111.

4.4.2 ALARM NOTIFICATION EMAIL

In order to configure the alarm by e-mail, you must:

1. You must first ensure that you enter the correct information in the controller (depending on your network) under the following options:
 - a. IP address
 - b. Default Gateway
 - c. Subnet mask
 - d. Primary DNS
 - e. Secondary DNS

You must restart the device for the changes to take place.

2. Access the Boiler Web Portal.
3. Click on the Installer / Communication menu.
4. Enter your e-mail under Recipient. You can also use your own mail server by entering the necessary data.
5. Then select the types of alarms you want to receive by e-mail.

If you want to send alarms to different e-mail addresses, simply enter a list of e-mails.

The parameters to enter on the web page are indicated on the screen shot below.

Name	Value
Activation alarm to email function	<input checked="" type="checkbox"/>
Host	<input type="text" value="pop3.vertisoftpme.com"/>
User	<input type="text" value="alertes.t2000@vertisoftmail.com"/>
Password	<input type="text" value="Centre64\$\$"/>
Sender	<input type="text" value="alertes.t2000@vertisoftmail.com"/>
Recipient	<input type="text" value="recipients e-mail"/>
Port	<input type="text" value="587"/>
Reset email list (*SMTP error)	<input type="checkbox"/>

Personal Email Server (Type: Gmail)

The M171 controller does not support SSL encryption. Thus, your SMTP Email server must accept an unencrypted connection.

Internet service providers usually have a specific server that accepts connections without encryptions. On-line messaging services, such as Hotmail, G-mail, do not accept unencrypted communications. In order to work around the problem, there are relay services such as SMTP2GO: <https://www.smtp2go.com>, to relay between controller communication and your messaging system. This service is free for up to 1000 emails per month.

4.5 BOILER STATUS DISPLAY SETTINGS

(Variables beginning with AV and BV are read variables, while variables beginning with "W" are editable)

Display	Description	BACnet Variable	Instance	Tag	BACnet Description
T. Set point	The set-point temperature of the boiler. The boiler will activate its elements accordingly in order to modulate its water outlet temperature.	AV_TBoilerSTP	0	8388661	---
T. Out Boiler	The temperature at the outlet of the VoltMax boiler.	AV_BoilerTOut	0	8388608	---
T. In Boiler	The temperature at the inlet of the VoltMax boiler. This sensor is only available on SCR models.	AV_BoilerTIn	1	8388609	---
T. Outdoor	This variable allows the outdoor temperature to be displayed in real time when the outdoor temperature sensor is correctly connected.	AV_OutdoorT	2	8388610	---
Boiler Pressure	This variable allows the reading of the pressure sensor inside the boiler.	AV_SensorPressureSignal	6	8388614	---
Actual power (kW)	The actual power used in kilowatt	AV_ActualPowerkw	8	8388616	---
Actual Power (%)	The actual power used in percentage of the nominal power.	AV_ActualPowerPrc	9	8388617	---
% max authorized power	The maximum permissible power as a percentage of the nominal power.	AV_CapLimitPrc	1	8388662	---
Consumption	The power consumption of the last cycle. You must first begin a history cycle (MAIN MENU / CONSUMPTION)	AV_Consommation	57	8388667	---
Actual Current (A)	This variable allows the reading of the current sensor inside the boiler. This sensor is only available on SCR models.	AV_SensorCurrentSignalL1 AV_SensorCurrentSignalL2 AV_SensorCurrentSignalL3	5 55 56	8388613 8388665 8388666	---
Demand W1	When requesting heating on W1, allowing the operation of the heating elements.	BV_HeatingW1	0	20971520	0 = No W1 demand 1 = W1 demand
Demand W2/DHW	When requesting heating on W2 or DHW, allowing the operation of the heating elements.	BV_HeatingW2	1	20971521	0 = No W2 demand 1 = W2 demand

Flow	When no heating elements are active, the calculated flow rate will be equivalent to 0 , because the theoretical flow is calculated according to the power used, T. Out Boiler and T. In Boiler T.	AV_WaterFlow	10	8388618	---
SCR Modulation %	Percentages of the SCR relay utilisation.	AV_ModSCR	7	8388615	
Stage #2	Status of stage #2	BV_RelStage2	5	20971525	0 = Stage 2 not working 1 = Operation of stage 2
Stage #3	Status of stage #3	BV_RelStage3	6	20971526	0 = Stage 3 not working 1 = Operation of stage 3
Stage #4	Status of stage #4	BV_RelStage4	7	20971527	0 = Stage 4 not working 1 = Operation of stage 4
Stage #5	Status of stage #5	BV_RelStage5	11	20971531	0 = Stage 5 not working 1 = Operation of stage 5
Stage #6	Status of stage #6	BV_RelStage6	12	20971532	0 = Stage 6 not working 1 = Operation of stage 6
Stage #7	Status of stage #7	BV_RelStage7	41	20971561	0 = Stage 7 not working 1 = Operation of stage 7
Stage #8	Status of stage #8	BV_RelStage8	42	20971562	0 = Stage 8 not working 1 = Operation of stage 8
Alarm HL/LWCO Alarm	Alarm triggered because of a high limit and low water level manual alarm.	BV_StatusAlarmHL/LW	14	20971534	0 = Normal operation 1 = Alarm activated
HL Alarm	Alarm triggered when the boiler's internal temperature is higher than the threshold.	BV_AlarmIntHL	15	20971535	0 = Normal operation 1 = Alarm activated
LL Alarm	Alarm triggered by the boiler's lack of capacity.	BV_AlarmLL	21	20971541	0 = Normal operation 1 = Alarm activated
Low Pressure Alarm	Alarm triggered by a low pressure.	BV_AlarmLowPressure	16	20971536	0 = Normal operation 1 = Alarm activated
High Pressure Alarm	Alarm triggered by a high pressure.	BV_AlarmHighPressure	17	20971537	0 = Normal operation 1 = Alarm activated
Flow Alarm	Alarm triggered by a flow problem.	BV_AlarmLowFlow	18	20971538	0 = Normal operation 1 = Alarm activated
Current Alarm	Alarm triggered by a current problem.	BV_AlarmCurrent	19	20971539	0 = Normal operation 1 = Alarm activated

Sensor Alarm	Alarm triggered by a sensor problem.	BV_AlarmSensor	20	20971540	0 = Normal operation 1 = Alarm activated
Backlight	Set controller backlight mode	WP_Backlight	54		0 = None 1 = 30 seconds 2 = Always on
Temperature units	Set controllers display temperature units	WP_TemperatureUnit	53		0 = F 1 = C
Flow units	Set controllers display flow units	WP_FlowUnit	37		0 = US GPM 1 = L/sec
Boiler model	The VoltMax boiler model.	---			---
Tension	The nominal voltage of the VoltMax boiler.	---			---
Firmware version	The controller's firmware version.	---			---
Program name	The controller's program name and version.	---			---

4.6 HEATING MODE W1 SETTINGS

(Variables beginning with AV and BV are read variables, while variables beginning with "W" are editable)

Display	BACnet variable	Instance	Tag	Description	Parameters	Default
Head demand W1	WP_HeatingW1	41	20971563	Allows to activate W1 heating demand when W1 is set to activate via BACnet	0 = Inactive 1 = Active	0
Operating Mode	WP_HeatingMod eW1	11	8388619	Selects the power limitation mode between Stop, Modulation T. Ext, DCC 0-10VDC and Fixed.	0 = Stop 1 = Outdoor Reset 2 = DCC 0-10VDC 3 = Fixed	Fixed

4.6.1 FIXED MODE

Configure the fixed set-point temperature

Display	BACnet Variable	Instance	Tag	Description	Selection	Default
W1 Set point	WP_FixedSTPT W1	22	8388630	Selects the fixed set-point temperature when there is demand on W1.	10 to 93 °C 50 to 200 °F	140 °F

4.6.2 OUTDOOR RESET MODE

Adjust the set-point temperature according to the outside temperature

This mode allows modulating the boiler output set-point temperature as a function of the outdoor temperature. The outdoor temperature value comes from a temperature sensor connected to the boiler controller.

If the outdoor sensor is not connected or if its circuit is open, an alarm signal will be displayed on the display (SE). The boiler temperature set-point will become the set value at **STPT Min T. Outdoor**.

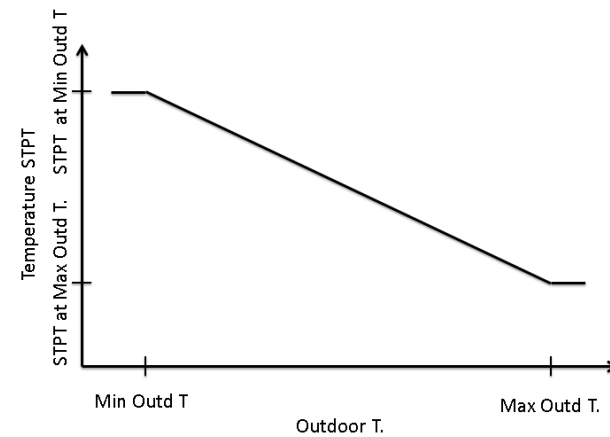

Figure 17 : Outdoor reset curve

Table 10 : OUTDOOR RESET MODE Settings

Display	BACnet Variable	Instance	Tag	Description	Parameters	Default
Calculated SPTP	AV_TBoilerSTPT CalculatedOUTRST	12	8388625	Current set-point temperature calculated based on the adjustment curve and the outside temperature	10 to 93 °C 50 to 200 °F	---
STPT at Min Outd T	WP_STPTatMinO utdT	13	8388621	Boiler set-point temperature when the outside temperature reaches the Min Outd T.	10 to 93 °C 50 to 200 °F	140 °F
STPT at Max Outd T	WP_STPTatMax OutdT	14	8388622	Boiler set-point temperature when the outside temperature reaches the Max Outd T.	10 to 93 °C 50 to 200 °F	80 °F
Outdoor T.	AV_OutdoorT	2	8388610	Displays the outside temperature in real time when the outdoor temperature sensor is properly connected.	-46 to 107 °C -50 to 250 °F	---
Min Outd T.	WP_MinOutdRst T	15	8388623	Minimum outside temperature (Set to the area's coldest average temperature)	-46 to 107 °C -50 to 250 °F	-10 °F
Max Outd T.	WP_MaxOutdRst T	16	8388624	Maximum outside temperature at which the building will need heating	-46 to 107 °C -50 to 250 °F	65 °F

4.6.3 MODE: DDC 0-10VDC

Modulation of the set-point temperature as a function of 0-10 VDC (Available only on SCR model)

This operating mode allows to modulate the set-point temperature of the water outlet of the boiler according to a 0-10VDC signal applied to the terminal block **0-10Vdc T** and **0-10Vdc G** from an external controller (Ex: An energy management software).

A heat demand (closed contact W1 and / or W2-DHW) must be present so that the boiler can heat up.

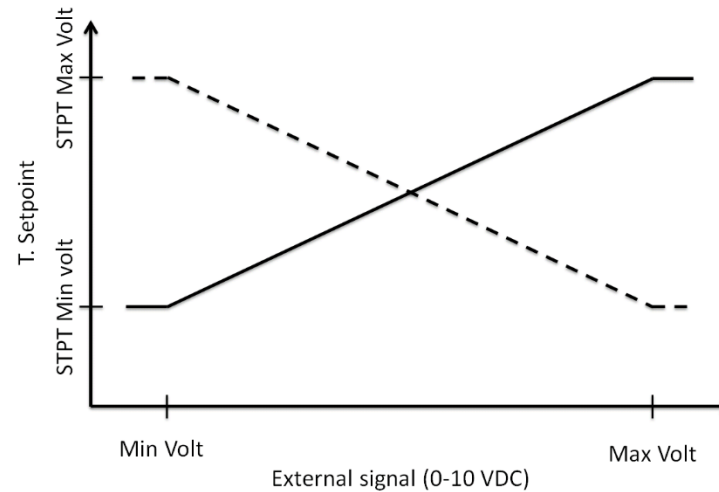

Figure 18 : Mode DDC 0-10 VDC

Table 11 : Specific parameters in DDC 0-10 VDC

Display	BACnet variable	Instance	Tag	Description	Parameters	Default
T. STPT 0-10VDC	AV_TBoilerSTPT CalculatedV	17	8388625	This variable represents the set-point temperature based on the voltage of the building control system.	°C or °F	---
STPT at Min Volt	WP_STPTatMinRemote010V	20	8388626	Set-point of the boiler temperature corresponding to the voltage level of Min Voltage .	°C or °F	80 °F
STPT at Max Volt	WP_STPTatMaxRemote010V	21	8388627	Set-point of the boiler temperature corresponding to the voltage level of Max Voltage .	°C or °F	140 °F
Actual voltage	AV_Remote010V STPT	3	8388611	Voltage emitted by the external controller in real time	0-10 V	---
Max Voltage	WP_MinRemoteV STPT	18	8388626	The maximum voltage that the external controller can send	0-10 V	10
Min Voltage	WP_MaxRemoteV STPT	19	8388627	The minimum voltage that the external controller can send	0-10 V	0

4.7 W2 MODE SET-POINT TEMPERATURE SETTINGS

(Variables beginning with AV and BV are read variables, while variables beginning with "W" are editable)

Display	BACnet Variable	Instance	Tag	Description	Selection	Default
Heat demande W2/DHW	WP_HeatingW2	42	20971564	Allows to select W1 heating demand source. BACnet or Local	Local BACnet	Local
Operating Mode	WP_HeatingModeW2	23	8388631	Select the boiler's operating mode during demand on W2 (None, W2 and DHW)	0 = W2 1 = DHW 2 = None	None

4.7.1 W2 MODE

Configures the fixed set-point temperature during demand on W2

Display	BACnet Variable	Instance	Tag	Description	Selection	Default
W2 Set point	WP_FixedSTPTW2	24	8388632	Selects the fixed set-point temperature during demand on W2.	10 to 93 °C 50 to 200 °F	175 deg F ⁰

4.7.2 DHW MODE

Configures the fixed set-point temperature during demand on DHW mode.

Display	BACnet Variable	Instance	Tag	Description	Selection	Default
T. Set-point DHW	WP_FixedSTPTECD	25	8388633	Selects the fixed set-point temperature during demand on W2 terminale in DHW mode	10 to 93 °C 50 to 200 °F	175 °F
T. Min Boiler	WP_FixedSTPTW0	26	8388634	Selects the boiler's minimum temperature. The boiler's heating elements will activate automatically to keep the hydronic system at the selected temperature.	10 to 93 °C 50 to 200 °F	150 °F

4.8 POWER LIMITATION MENU SETTINGS

(Variables beginning with AV and BV are read variables, while variables beginning with "W" are editable)

You can control the boiler power with different modes. Their configuration is below.

Display	BACnet Variable	Instance	Tag	Description	Selection	Default
Limitation Mode	WP_CapLimitMode	31	8388639	Select the power limitation between None, Manual, DCC 0-10VDC, T. Ext and Scheduled.	0 = None 1 = Manual 2 = DCC 0-10VDC 3 = T. Ext 4 = Scheduled	---

4.8.1 MANUAL MODE

The maximum power is set manually.

Display	BACnet Variable	Instance	Tag	Description	Selection	Default
Current authorized max kW	WP_ManualCapLimit	32	8388640	Configures the maximum electrical power that the boiler will use.	0 to maximum rated power	---

4.8.2 0-10 VDC MODE

An external 0-10 VDC controller is used to adjust the maximum power.

Display	BACnet Variable	Instance	Tag	Description	Selection	Default
Current authorized max power (%)	AV_CapLimitPrc	1	8388662	The value of power (%) calculated based on the current and the boiler's nominal operating voltage	0 to maximum rated power (%)	---
Minimum Power Volt (kW)	WP_MinRemoteVCapLimit	33	8388641	The boiler's maximum power when the external controller voltage is at Min Voltage	0 to maximum rated power	0
Maximum Power Volt (kW)	WP_MaxRemoteVCapLimit	34	8388642	The boiler's maximum power when the external controller voltage is at V for max. cap.	0 to maximum rated power	---
Current Signal 0-10V	AV_Remote010V Cap	4	8388612	Voltage emitted by the external controller in real time	0-10 V	---
Min Voltage (VDC)	WP_CapLimitatMinRemote010V	35	8388628	The voltage representing the external controller's minimum set-point	0-10 V	0
Max Voltage (VDC)	WP_CapLimitatMaxRemote010V	36	8388629	The voltage representing the external controller's maximum set-point	0-10	10

4.8.3 T. EXT MODE

Maximum power modulation is based on the outside temperature. Power modulation is shown below.

If the external sensor is not connected or there is a problem with the sensor, then the power will be limited according to **Cap. At T. Ext. Min.**

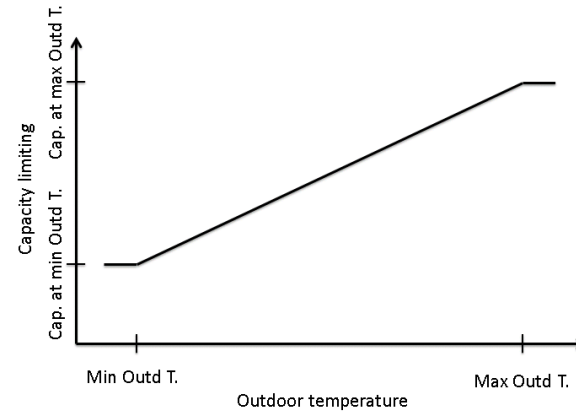

Figure 19: Adjustment curve according to the T. ext mode

Display	BACnet Variable	Instance	Tag	Description	Parameters	Default
Current authorized max power (%)	AV_CapLimitPrc	54	8388662	The value of power (%) calculated based on the current and the boiler's nominal operating voltage	0 to maximum rated power (%)	---
Cap. At T. Ext. Min	WP_CapLimitatMinOutdT	37	8388645	Maximum authorized capacity according to T. Ext. Min Ex. Maximum power is 170 kW for T. Ext min	0 to maximum rated power	---
Cap. At T. Ext. Max	WP_CapLimitatMaxOutdT	38	8388646	Maximum authorized capacity according to T. Ext. Max Ex. Maximum power is 120 kW for T. Ext min	0 to maximum rated power	---
Actual T. Exterior	AV_OutdoorT	2	8388610	This variable allows you to view the outside temperature in real time when the outside temperature sensor is properly connected.	-46 to 107 °C -50 to 250 °F	---
T. Ext. Min	WP_MinOutdTCapLimit	39	8388647	Minimal outside temperature used to adjust the maximum power	-46 to 107 °C -50 to 250 °F	-10 F
T. Ext. Max	WP_MaxOutdTCapLimit	40	8388647	Maximum outside temperature used to adjust the maximum power	-46 to 107 °C -50 to 250 °F	65 F

4.8.4 SCHEDULE MODE

Power can be modulated according to a fixed schedule. This can be programmed in the **Schedule Setting** menu.

Display	BACnet variable	Instance	Tag	Description	Parameters	Default
Current authorized max power (%)	AV_CapLimitPrc	1	8388662	The value of power (%) calculated based on the current and the boiler's nominal operating voltage	0 to maximum rated power (%)	---
Cap In Schedule	WP_CapLimitDay Mode	41	8388649	Power limitation when the boiler internal clock is within the power limitation schedule.	0 to maximum rated power	---
Cap Out Schedule	WP_CapLimitNightMode	42	8388650	Power limitation when the boiler internal clock is outside the power limitation schedule.	0 to maximum rated power	---
Schedule	---			Configuring the boiler power limitation schedule. In order to operate correctly, you must first adjust the internal boiler clock in the Clock Setting menu.	---	---

4.9 AUXILIARY BOILER SETTINGS

(Variables beginning with AV and BV are read variables, while variables beginning with "W" are editable)

Display	BACnet variable	Instance	Tag	Description	Parameters	Default
Auxiliary boiler setup	WP_AuxBoilerMode	43	8388651	Setup auxiliary boiler mode	0 = None 1 = Backup 2 = Ext. Contact 3 = Manual 4 = Bi-energy	0

The system allows control of an auxiliary boiler to the system. The different configuration options are shown below.

In order for the boiler to start, two conditions must be met:

The water outlet temperature of the Voltmax boiler must be below the start-up temperature Aux.

$$(T. \text{ Out Boiler} < (T \text{ Set-point} - \text{Delta T. Aux Start}))$$

The water outlet temperature of the Voltmax boiler must be below the start-up temperature Aux. for a period of X minutes (**Start Delay Aux**), after the Voltmax boiler is at 100% of its authorized power.

In order for the auxiliary boiler to turn off, the water outlet temperature of the Voltmax boiler must be above the Aux.

$$T \text{ Out Boiler} > (T. \text{ Set-point} - \text{Delta T. Aux Stop})$$

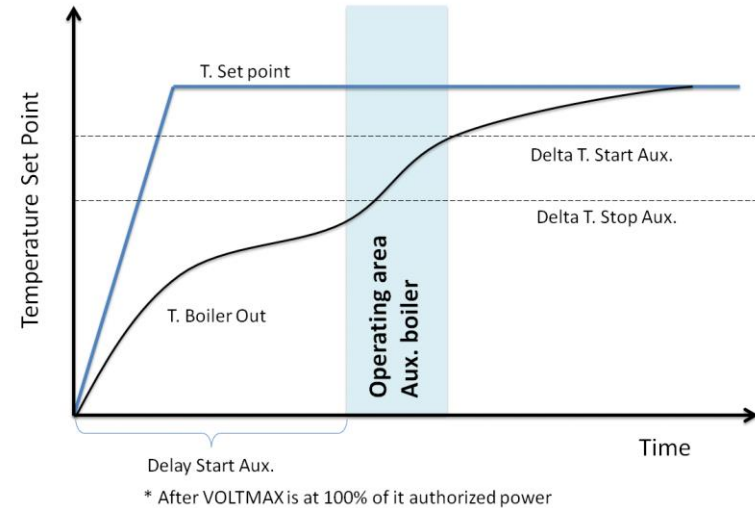

4.9.1 BACKUP MODE

Configures a second boiler as a backup.

Display	BACnet variable	Instance	Tag	Description	Parameters	Default
STPT Source	WP_STPTSourceAux	22	20971542	Selects the source used to control the set-point temperature. Auxiliary means that the set-point will be determined by the auxiliary boiler. The VoltMax boiler therefore has no set-point temperature and is only used to activate the auxiliary boiler relay. Voltmax means that the set-point temperature will be determined by the VoltMax boiler.	Auxiliary or VoltMax 0 = Auxilliary 1 = VoltMax	VoltMax
Delta T. Start Aux.	WP_DeltaTStartAux	44	8388652	This option adjusts the temperature differential (set-point temperature – Water outlet temperature) used to activate the auxiliary boiler.	0 to 55 °C 0 to 100 °F	20 °F
Delta T. Stop Aux.	WP_DeltaTStopAux	45	8388653	This option configures the temperature differential (set-point temperature – Water outlet temperature) in the VoltMax boiler used to deactivate the auxiliary boiler.	0 to 55 °C 0 to 100 °F	5 °F
Delay Start Aux.	WP_DelayStartAux	46	8388654	This option adjusts the delay before activating the auxiliary boiler.	Min	10

4.9.2 EXTERNAL CONTACT MODE

This mode selects the hydronic system heating source (VoltMax boiler or auxiliary boiler) using the **BI-E** terminal's electrical switch.

Display	BACnet Variable	Instance	Tag	Description	Settings	Default
STPT Source	WP_STPTSource Aux	22	20971542	Selects the source used to control the set-point temperature. External means that the set-point will be determined by the auxiliary boiler. The VoltMax boiler therefore has no set-point temperature and is used only to activate the auxiliary boiler's relay. Internal means that the set-point temperature will be determined by the VoltMax boiler.	External or internal	Internal

4.9.3 MANUAL MODE

Manual mode is used to select the system's operating mode (Electric or auxiliary).

Display	BACnet Variable	Instance	Tag	Description	Selection	Default
Active Boiler	WP_ActiveBoiler	23	20971543	This option selects which boiler is in operation; either the VoltMax boiler (electric) or the auxiliary boiler (auxiliary).	VoltMax ou Auxiliary 0 = VoltMax	VoltMax

4.9.4 BI-ENERGY MODE

This mode selects the hydronic system heating source (VoltMax boiler or auxiliary boiler) using the **BI-E** terminal's electrical switch. The benefit of this mode is that the system can operate the back-up boiler when needed.

Display	BACnet variable	Instance	Tag	Description	Parameters	Default
Bi-energy	BV_SignalBiEnergy	2		Displays Bi-Energy signal state		---
Bi-Energy Source	WP_SignalBiEnergy	43	20971567	Allows to select Bi-energy activation contact source. BACnet or Local	0 = Auxilière 1 = VOLTMAX	Auxilière
STPT Source	WP_STPTSource Aux	22	20971542	Selects the source used to control the set-point temperature. Auxiliary means that the set-point will be determined by the auxiliary boiler. The VoltMax boiler has no set-point temperature and is only used to activate the auxiliary boiler relay. Voltmax means that the set-point temperature will be determined by the VoltMax boiler.	Auxiliary or VoltMax 0 = Auxiliary 1 = VoltMax	VoltMax
Delta T. Start Aux.	WP_DeltaTStartAux	44	8388652	This option adjusts the temperature differential (Set-point temperature – Water outlet temperature) used to activate the auxiliary boiler.	0 to 55 °C 0 to 100 °F	20 °F

Delta T. Stop Aux.	WP_DeltaTStopAux	45	8388653	This option configures the temperature differential (Set-point temperature – Water outlet temperature) in the VoltMax boiler used to deactivate the auxiliary boiler.	0 to 55 °C 0 to 100 °F	5 °F
Delay Start Aux.	WP_DelayStartAux	46	8388654	This option adjusts the delay in minutes before activating the auxiliary boiler.	Min	10

4.10 LIMIT CONFIGURATION MENU SETTINGS

(Variables beginning with AV and BV are read variables, while variables beginning with "W" are editable)

Display	BACnet variable	Instance	Tag	Description	Settings	Default
High Limit T	WP_HighLimitTemp	47	8388655	Adjusts the temperature high limit at which the alarm triggers. If the water temperature leaving the boiler exceeds the alarm's high limit, it will trigger an HL alarm and the boiler's heating elements will be deactivated.	0 to 92 °C 0 to 199 °F	195 °F
Low Limit ON/OFF	WP_DesactivateAlarmLL	30	20971550	Desactivates the low limit detection function (see* below)	0=OFF 1=ON	ON
Delta T. LL*	WP_DeltaTLL	48	8388656	Adjusts the temperature differential to activate the LL alarm.	0 to -55 °C 0 to -99 °F	-20 °F
Delay LL (min)*	WP_DelayLL	49	8388657	Adjusts the LL alarm trigger delay.	0 to 180 min	60 min
Pressure sensor	WP_ActivatePressureSensor	24	20971544	Activates the boiler's internal pressure sensor module.	OFF / ON 0 = Off ; 1 = On	ON
Actual pressure	AV_SensorPressureSignal	6	8388614	Reads the boiler's internal pressure sensor.	---	---
Current sensor	WP_ActivateCurrentSensor	25	20971545	Activates the current sensor module. This module is available on SCR models only	OFF / ON 0 = Off ; 1 = On	ON
Calculated current	AV_CalculatedCurrentSignal	50	8388658	Used to view the VoltMax boiler's theoretical electric consumption current.	---	---
Actual current	AV_SensorCurrentSignal	5	8388613	View current as measured by a sensor.	---	---

*The LL (low limit) function aims to identify a potential anomaly of the boiler by detecting a potential lack of power that makes the temperature of the water at the boiler outlet to be anomaly lower than the set temperature during a predefined time period (see section 6.2.3).

4.11 CONFIG. ALARM MENU SETTINGS

(Variables beginning with AV and BV are read variables, while variables beginning with "W" are editable)

Display	BACnet Variable	Instance	Tag	Description	Settings	Default
Occupation mode	WP_Schedule_On	44	20971564	Allows to select Bi-energy activation contact source. BACnet or Local	Local BACnet	Local
Status: HL/LWCO alarm	BV_StatusExtAlarm	28	20971548	Displays the external alarm status. The external alarm contact is activated only if a high limit or low water level alarm occurs.	0 = Off 1 = On	---
Status: external HL/LWCO alarm	BV_ExtAlarmHiLimit_LWCO	3		Displays the external alarm status. The external alarm contact is activated only if a high limit or low water level alarm occurs.	0 = Off 1 = On	---
Silence Alarm	WP_SilenceAlarm	27	20971547	Temporarily suspends the alarm.	0 = Off 1 = On	Off
Status : Louckdown	BV_LockDown	31		Displays the lockdown status	0 = Off 1 = On	---
Reset Lockdown	WP_ResetLockDown	29	20971549	Cancels the Lockdown mode without resetting the unit. Resetting the unit is required when it is in LOCK-OUT mode , following high external temperature or low water level alarms over a short period.	0 = Off 1 = On	Off
Status : External alarm contact	BV_ExtAlarmContact	8		Displays the external alarm contact state	0 = Off 1 = On	---
External low limit alarm setup	WP_AlmDiffLL_ContExt	46		Configure external alarm contact to give a low limit alarm	0 = Inactive 1 = Active	Inactive
External flow alarm setup	WP_AlmFlow_ContExt	47		Configure external alarm contact to give a water flow alarm	0 = Inactive 1 = Active	Inactive
External current alarm setup	WP_AlmCurrent_ContExt	48		Configure external alarm contact to give a current alarm	0 = Inactive 1 = Active	Inactive
External sensor alarm setup	WP_AlmSensor_ContExt	49		Configure external alarm contact to give a sensor alarm	0 = Inactive 1 = Active	Inactive
External high limit alarm setup	WP_AlmTempHL_ContExt	50		Configure external alarm contact to give a temperature high limit alarm	0 = Inactive 1 = Active	Inactive

External high pressure alarm setup	WP_AlmHighPre ss_ContExt	51		Configure external alarm contact to give a high pressure alarm	0 = Inactive 1 = Active	Inactive
External low pressure alarm setup	WP_AlmLowPres s_ContExt	52		Configure external alarm contact to give a low pressure alarm	0 = Inactive 1 = Active	Inactive

4.12 OCCUPATION MENU SETTINGS

(Variables beginning with AV and BV are read variables, while variables beginning with "W" are editable)

Display	BACnet Variable	Instance	Tag	Description	Settings	Default
Status : Occupation	BV_OCC	4		Displays occupation mode status	0 = Off 1 = On	---
Occupation Mode	WP_ActivateOccupationMode	32	20971552	Activates the Occupation function.	0 = Off 1 = On	---
Source OCC	WP_SourceOccupation	33	20971553	Selects the source used to determine the building's occupation schedule.	0 = Schedule 1 = Contact OCC	
Lowering T.	WP_LoweringTInnooccupation	52	8388660	Lowers the set-point temperature.	---	Off
Occupation Status	BV_StatusOccupation	34	20971554	Displays the Occupation mode status. Off: Day mode; the set-point temperature is not lowered On: Night mode; the set-point temperature is lowered according to the configuration	0 = Off 1 = On	On
Force Day Mode	WP_ForceOccupationDay	35	20971555	Forces the Day mode. The set-point temperature will not be lowered.	0 = Off 1 = On	Off

4.13 BOOST MENU SETTINGS

(Variables beginning with AV and BV are read variables, while variables beginning with "W" are editable)

Display	BACnet Variable	Instance	Tag	Description	Settings	Default
Mode BOOST	WP_ActivateMod eBoost	36	20971556	This option enables the BOOST functionality.	0 = Off 1 = On	Off

4.14 WARM WEATHER SHUTDOWN MENU SETTINGS

(Variables beginning with AV and BV are read variables, while variables beginning with "W" are editable)

Display	BACnet Variable	Instance	Tag	Description	Settings	Default
Warm Weather Shutdown	WP_ActivateWar mWeatherSD	26	20971546	Shuts down the boiler when the outside temperature reaches a specific temperature. This temperature can be set in the Warm Weather Shutdown Temperature box .	OFF / ON 0 = Off ; 1 = On	OFF
T. Ext Shutdown WWSD	WP_WarmWeath erSDTemp	51	8388659	Sets the outside temperature that activates the Warm Weather Shutdown , if it shuts down the boiler.	0 to 55 °C 0 to 99 °F	68 °F
Current Ext. T.	AV_OutdoorT	2	8388610	Shows the outside temperature in real time.	-46 to 107 °C -50 to 250 °F	---

SECTION 5 : BOILER START UP



WARNING

Before operating this boiler, be sure to read and follow these instructions, as well as the warnings printed in this manual. Failure to do so can result in unsafe operation of the boiler resulting in property damage, bodily injury, or death. Should you have any problems reading, following or difficulty in understanding the instructions in this manual, STOP, and get help from a qualified person.

Do not turn on the boiler unless it is filled with water. Do not turn on the boiler if the cold-water supply shut-off valve is closed.

After the boiler, has been plumbed and wired, it is now ready to be set for automatic operation

5.1 STARTUP PREPARATION

Remove the lid of the boiler and install the temperature probe which is below this lid with a red label indicating the message "IMPORTANT" hanging outside the control panel.

This sensor is used to provide the output water temperature to the boiler controller. Therefore, it shall be installed in one of the two immersion wells indicated below. Insert in the immersion well located on the same side of the selected water output connection.

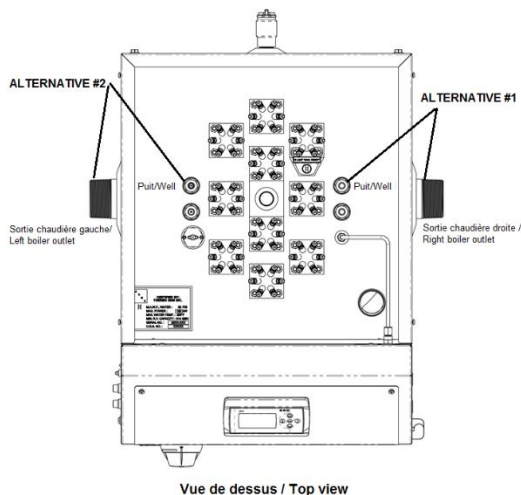

Open the service valves at the outlet of the boiler and the cold-water supply valve (fill or makeup water valve) to boiler.

Open the relief valve on top of the boiler in order to purge the air out of the boiler tank during the fill process

Leave all shutoff valves open.

Check system for leaks and repair. Purge air from all the heating distribution zones.

Bleed air from different areas of the heat distribution system.

Check boiler pressure gage reading. The indicated pressure should be lower than the pressure relief valve design rating.

5.2 ADJUSTEMENT OF THE CONTROLLER OPERATING PARAMETERS

After the system has been manually purged of air, and all components (valves, vents, and controllers) have been set properly, the boiler can be started.

Never operate this boiler until this has been done.

- 1) Make sure that there is no heat demand or startup authorisation on W1 and W2 contactors and that the ON/OFF switch on the left side of the panel is at OFF.
- 2) Turn on the boiler alimentation circuit and the disconnect switch (option).
- 3) Turn on the boiler ON/OFF switch. You should hear the mains contactors engaging and see the controller screen turn on. The heating elements shall not come on as long as there is no W1 or W2 heat demand.
- 4) Enter the appropriate parameters in the controller to obtain a proper operation of the heating system on wich to boiler is installed. The acces the menu, press "OK", then select "BOILER SETTING" and entre the password "1111". Consult section four of this manual to adjust the paramaters.
- 5) Make sure that the high limit parameters of the boiler are set at the appropriate values for the application.
- 6) The high limit adjustment is possible trough the "LIMIT setting" menu and should be adjusted 10 to 15°F above the maximum

operation temperature selected. Proceed to the adjustment of the mechanical high limit control localized on the right in the low voltage electric compartment. It shall be adjusted 10 to 15F higher than the controller high limit.

5.3 STARTUP PROCEDURE



Before starting the boiler, make sure that the heating distribution design is made so that the heating elements will come on only when water is circulating in the boiler.

- 1) Apply a heat demand. If the boiler target temperature is higher than the boiler water temperature, the heating elements shall come on in sequence more or less rapidly depending on the differential between the values. If the value indicated is "---" it is because the authorization or start up signal is not established.
- 2) When the boiler capacity has reached 100% as displayed on the controller, measure the amperage and voltage values drawn by the unit. These values shall be close to those shown on the boiler name plate.
- 3) Slow down the heat demand from the heating system. The boiler temperature shall gradually increase and the boiler capacity shall drop gradually and stabilize when the boiler temperature will reach a temperature near the target temperature.
- 4) When the heating request is completed, the heating elements stop working.
- 5) Check the operation of the adjustable high-limit mechanical control
- 6) Check the operation of the Low Water Cut OFF by pressing its test button during 5 sec. The button is located on the left side of the control panel

SECTION 6 :TROUBLESHOOTING

The troubleshooting section shows the various error messages that can occur during abnormal operation of the boiler. It is possible to change the limits of some alarms on the controller in the **Limit Setting**.

Alarm menu Symbols

	An alarm is active
	The boiler is in lock mode
HL	The high limit temperature has been reached
LL	Low limit (Lack of capacity)
P	Pressure problem alarm
A	Amperage problem alarm
F	Flow problem alarm
Se	Sensor problem alarm
	The internal clock battery level is low

6.1 WARNING LIGHTS

The LEDs above the navigation buttons indicate 3 different boiler states

Active warning light	Boiler status
Green	Normal operation of the boiler
Yellow	One or more alarms are active. These alarms do not prevent the operation of the boiler; the boiler continues to operate in normal mode. Ex. The controller detects a problem with the amperage reading sensor.
Red	A critical alarm is active, accompanied by the buzzer (if active). Ex. A high limit alarm is active

6.2 OPERATING PROBLEM IDENTIFICATION

An alarm log is available in the **BOILER CONFIG / ALARM / ALARM LOG**. Each alarm is recorded with its alarm code, the time and date. The register can record up to 30 alarms.

6.2.1 EXTERNAL HL / LWCO

When this alarm is present, the red alarm indicator light will glow.



This alarm happens when one of the following contacts is open: the adjustable mechanical high limit (located at the right inside the control compartment), the manual reset high limit (located in the heating elements compartment), a low level of water (located at the left of the control panel) or an external contact connected to "EXT. HL" terminals.

The alarm contact will be activated, the heating elements will stop working. The boiler will restart again when the water level or the other conditions returns to normal. **If this alarm happens 3 times in 1 hour or for 60 consecutive minutes, the boiler will be set in Lock out mode.**

6.2.2 SENSOR (SE)

The **Sensor** alarm indicates that a current, pressure or temperature sensor is defective. This alarm will also be triggered if the external temperature is not connected and an operating condition requires this sensor. Generally the alarm is coupled with the letters A, P and F which indicates the defective sensor. This condition does not turn off the boiler (except in the case of a defective water outlet temperature sensor). The yellow indicator light stays on as long as the alarm condition is active.

The alarm contact can be configured to activate when this anomaly happens (See Alarm menu) See Table 12 for comparison of Resistance measurements against temperature for the temperature sensors.

6.2.3 LOW LIMIT (LL)

The **LL alarm** is activated when the temperature differential between the set-point temperature and the boiler output temperature is higher than **Delta T. during a defined period "LL delay"**.

The heating elements remain in operation. The screen will automatically return to its normal state when the temperature of the boiler approaches the set temperature.

This function can detect a possible lack of power from the boiler and therefore possible anomalies

of certain components. This function can be cancelled in the “Config Boiler / Limit setting” and is generally not activated when the power limitation function of the boiler is activated.

The alarm contact can be configured to activate when this anomaly happens (See Alarm menu)

6.2.4 FLOW (F) (Available only on SCR model)

The **flow** alarm is triggered when the theoretical flow calculated from the water input and output temperature differential (max.50F) is above the authorized flow limit.

This condition triggered by a lack of flow does not turn off the boiler but activates a yellow indicator light as long as the condition is active.

The alarm contact can be configured to activate when this anomaly happens (See Alarm menu)

6.2.5 CURRENT (A)

The **Current** alarm is triggered when there is a difference between the measured current **on each phase** and the calculated theoretical current. This may indicate an electrical problem from an electrical components that will lead in a lack of power.

This condition triggered does not turn off the boiler but activates a yellow indicator light as long as the condition is active. After two trials of activating a defective stage, it will be cancelled. If more than 50% of the stages are detected as defective, the alarm contact will close and the red light will light up.

The defective stage can be identified on the controller display because its corresponding symbol will not appear under the ‘stage’ identification. It could be also identified on the controller boiler status menu. The ON/OFF switch located on the left side of the control panel will have to be cycle when the problem will be solved.

If required, the alarm current can be neutralized in the “Boiler Config / limit / Amp” menu.

The alarm contact can be configured to activate when this anomaly happens (See Alarm menu)

6.2.6 HL TEMPERATURE (HL)

The outlet temperature of the boiler is above the high limit allowed. This alarm triggers the deactivation of the heating elements of the boiler. The boiler is restarted when the temperature drops below the high limit (and the set-point)

The alarm contact can be configured to activate when this anomaly happens (See Alarm menu)

6.2.7 LOW PRESSURE (P)

The **Low-Pressure** alarm “P” is activated when the pressure inside the boiler is below the allowed limit (default: 5 psi).

This condition triggered by a lack of flow does not turn off the boiler but activates a yellow indicator light as long as the condition is active.

The alarm contact can be configured to activate when this anomaly happens (See Alarm menu)

6.2.8 HIGH PRESSURE (P)

The **High-Pressure** alarm P is activated when the pressure inside the boiler gets to the value selected in the “Config Limit” of the controller. This value must be lower than the pressure setting of the boiler pressure relief valve. This valve must not have a setting over the boilers design maximum pressure.

If required, the pressure alarm can be neutralized in the “Boiler Config / limit / pressure” menu.

The alarm contact can be configured to activate when this anomaly happens (See Alarm menu).

6.2.9 BATTERY LOW LEVEL

The low-level battery alarm appears when the battery used by the internal clock is at a low level. The battery needs to be replaced. To get the replacement procedure, contact our technical service.

6.2.10 LOCK OUT

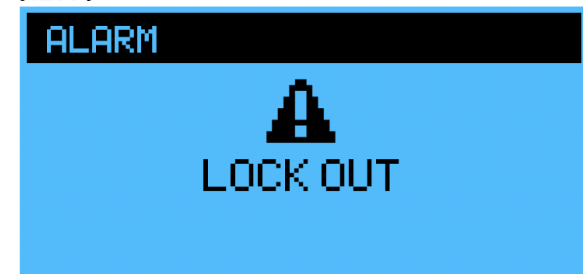

Lock out mode is activated after 3 major alarms (red indicator light) have been activated within one hour or when a major alarm (high limit output water temperature detected by the external temperature sensor or low water level condition) is maintained activated during the same time period. When the lock mode is activated, the boiler stops and can only be restarted by restarting the boiler (to the left of the control panel) or by using the reset Lock Out function (in the alarm setting menu). The alarm contact will be activated. The details of this menu can be found in section 4.11

Table 12 : Resistance (Ohm) according to the outdoor sensor measuring temperature

Temperature		Resistance	Temperature		Resistance	Temperature		Resistance	Temperature		Resistance
°F	°C	Ω	°F	°C	Ω	°F	°C	Ω	°F	°C	Ω
-50	-46	490 813	20	-7	46 218	90	32	7 334	160	71	1 689
-45	-43	405 710	25	-4	39 913	95	35	6 532	165	74	1 538
-40	-40	336 606	30	-1	34 558	100	38	5 828	170	77	1 403
-35	-37	280 279	35	2	29 996	105	41	5 210	175	79	1 281
-30	-34	234 196	40	4	26 099	110	43	4 665	180	82	1 172
-25	-32	196 358	45	7	22 763	115	46	4 184	185	85	1 073
-20	-29	165 180	50	10	19 900	120	49	3 760	190	88	983
-15	-26	139 402	55	13	17 436	125	52	3 383	195	91	903
-10	-23	118 018	60	16	15 311	130	54	3 050	200	93	829
-5	-21	100 221	65	18	13 474	135	57	2 754	205	96	763
0	-18	85 362	70	21	11 883	140	60	2 490	210	99	703
5	-15	72 918	75	24	10 501	145	63	2 255	215	102	648
10	-12	62 465	80	27	9 299	150	66	2 045	220	104	598
15	-9	53 658	85	29	8 250	155	68	1 857	225	107	553

6.3 FUSES

Delay fuses with the same capacity and voltage must be used when replacing all of the boiler fuses except for the power fuses that are “fast acting” type T.

6.4 CONTACTOR

If one or more contactor must be replaced, make sure that the terminal screws are well tightened to avoid an overheating of its contacts. The required torque is indicated on the contactor label. A verification of the screw torque should be made annually particularly on the first years of service.

If a contactor is noisy or defective, it can be temporarily deactivated. To do so, go to the “Boiler config / Neutralisation of stage” menu and select “Active” or “Inactive” on the defective stage. The yellow light will come on and the stage will need to be reset to “Active” when the contactor will be changed.

6.5 HEATING ELEMENTS

If a heating element must be replaced, make sure that the replacement has identical power and voltage as the old one. The model number and technical characteristics are indicated on the side of the mounting flange of the element.

The sealing gasket must also be replaced by an identical model as the one procured by Thermo 2000.

The torque for the bolts retaining the flange should be 12lb.ft.

If the elements have been in contact with water or a very humid environment, dry them completely before putting them under voltage. Verify the state of the electrical isolation of the element and the ground with a “Megger” test.

If elements are blown at their extremities, make sure there is no sediment deposits in the tank before installing new elements. If deposits are present, a sieve or other accessories preventing sediment deposits shall be installed.

6.6 TEMPERATURE SENSOR

Water outlet sensor:

The sensor is located in an immersion well located in the heating elements compartment on the top of the boiler (illustration 5.1) and the resistance vs temperature value is indicated in table 12 above.

Water intake sensor (on SCR models only):

The sensor is located in an immersion well in the back and at the bottom of the boiler. To access it, remove the plastic plug located right above the drain valve.

6.7 EXTERNAL HIGH LIMIT CONTROL

Fix high limit control with manual arming

It is located in the heating elements compartment and fixed in place by a metal plate fixed to one of the element's flange.

During the installation one must make sure that the surface of contact is clean and that the control is firmly locked in place.

Adjustable high limit automatic control

It is located on the right in the control compartment of the boiler.

It must always be adjusted at 10°F above the high limit temperature indicated in the operation parameter of the controller.

6.8 INTERNAL CLOCK

If the internal clock is used and it does not keep its reading (goes back to 0:00), the battery on the electronic controller needs to be changed and the clock has to be reconfigured afterwards. Contact thermo 2000 technical support for the battery replacement procedure.

SECTION 7 : MAINTENANCE

Properly maintained, your boiler will provide years of dependable, trouble free service. It is recommended that a regular routine maintenance program be established and followed by the user. Components are subject to eventual failure that requires service. Failure to use the correct procedures or parts in these circumstances may make the unit unsafe or reduce the life of the boiler.

The owner should have the following inspection and maintenance procedures performed:

7.1 BOILER WATER PIPING

VISUAL INSPECTION

Check all piping for signs of leakage near joints, unions and shut-off valves. Repair without delay to avoid new water to enter the closed circuit and cause corrosion.

7.2 PRESSURE RELIEF VALVE

TWICE A YEAR

Check for possible leak at the outlet of the safety relief valve. If a leak is detected and the pressure at the indicator is less than 28psi, change the safety relief valve with a new one having similar characteristics. If the pressure is higher than 28psi, ask your heating service agency to determine the cause of the high pressure and have it corrected rapidly. Do not plug the outlet of this valve if a dripping condition occurs.

7.3 AIR PURGE

TWICE A YEAR

Check for proper operation of the automatic air purgers and activate manual air vents to eliminate air present.

7.4 ELECTRICAL INSPECTION

ANNUALLY

It is recommended to perform a visual inspection of the boiler electric compartment annually, during the heating season, to ensure it is watertight and that there are no signs of component or wiring overheating. Repair as soon as possible if necessary. Defective components should always be replaced with the Original Manufacturer's parts.

The inspection should also include a verification of the torque of all the terminals screws and particularly the power contactors. The inspection should follow with a verification of the main temperature controls in operation as well as an amperage and voltage reading to verify the proper operation of all the heating elements.

WARNING

The manufacturer's warranty DOES NOT cover a tank breakage caused by improper installation or maintenance. If the boiler safety valve opens periodically, this may be caused by the expansion tank.

Immediately call a qualified technician to inspect and remedy the problem.

NOTE: To prevent premature tank failure, the air trapped inside the system must be purged periodically.

DANGER

Before manually operating the relief valve, make certain no one will be sprayed with the hot water released by its opening. The water may be hot enough to create a SCALD hazard. The water released should be directed to a suitable drain to prevent injury or damage.

VoltMax LIMITED WARRANTY

Warranty Coverage for residential Installation

Thermo 2000 Inc. hereby warrants that the VoltMax tank installed in a normal residential service shall be exempt of any leak for ten (10) years from the purchase date. The warranty is effective as long as the original residential purchaser owns the home in which the unit was originally installed. Residential setting shall mean usage in a single-family dwelling in which the consumer resides on a permanent basis. Also, residential setting shall mean use in multiple family dwellings in which one (1) VoltMax boiler is to be used in only one (1) dwelling. In the event that a leak should develop and occur within this limited warranty period due to defective material or workmanship, such leak having been verified by an authorized company representative, Thermo 2000 Inc. will repair or replace at our sole option the failed unit with the nearest comparable model at the time of replacement.

The residential owner is responsible for all costs associated with the removal and reinstallation, shipping and handling to and from Manufacturer. The replacement unit will be warranted for the remaining portion of the original Warranty.

Warranty Coverage for Commercial Installation

Thermo 2000 Inc. warrants to the original purchaser that the VoltMax tank installed in a commercial setting shall be exempt of any leak for ten (10) years from the purchase date. Commercial setting shall mean use in other than residential setting stated above in the residential setting definition. In the event that a leak should develop and occur within this limited warranty period due to defective material or workmanship, such leak having been verified by an authorized company representative, Thermo 2000 Inc. will repair or replace at our sole option the failed unit with the nearest comparable model at the time of replacement.

The original purchaser is responsible for all costs associated with the removal and reinstallation, shipping and handling to and from Manufacturer. The replacement unit will be warranted for the remaining portion of the original Warranty.

Limited two-year warranty on all VoltMax components & parts

All other VoltMax components & parts are warranted for a period of two (2) years against defects due to defective material or workmanship. The original purchaser is responsible for all costs associated with the removal and reinstallation, shipping and handling to and from Manufacturer. The components, repaired or replaced are warranted for the residual period of the initial warranty on the unit.

Limitations

Thermo 2000 shall not be responsible for any damage, loss, and inconvenience of any nature whatsoever, directly or indirectly, relating to the breakdown or malfunction of the unit. This warranty limits its beneficiary's rights. Nevertheless, the beneficiary may have other rights, which vary from state to state.

This warranty replaces any other expressed or implicit warranty and constitutes the sole obligation of Thermo 2000 towards the consumer. The warranty does not cover cost of removal, reinstallation or shipping to repair or replace the unit, nor administration fees incurred by the original consumer purchaser.

Thermo 2000 reserves its rights to make changes in the details of design, construction, or material, as shall in its judgment constitute an improvement of former practices.

This warranty is valid only for installations made within the territorial limits of Canada and the United States.

Warranty service procedure

Only authorized VoltMax retailers may handle warranty claims. The owner or contractor must provide the defective equipment or components to Thermo 2000 with the following details: the model, the serial number, a copy of the original invoice and the owner identification certificate.

Exclusions

This warranty is void and shall not apply if:

- A) Defects or malfunctions resulting from installation, repair, maintenance and/or usage that are not done in conformity with the manufacturer's installation manual; or
- B) Defects or malfunctions resulting from installation, maintenance, or repair that are not done in accordance with regulations in force; or
- C) Defects or malfunctions resulting from improper installation, maintenance or repair done carelessly or resulting from consumer damage (improper maintenance, misuse, abuse, accident or alteration); or
- D) Installation in which a relief valve (pressure) is not installed or if it is not functioning properly, or when it is not connected to a drain to avoid damage to the property; or
- E) Installation in which liquid circulating in the tank does not remain in closed circuit or installation in which piping is leaking; or
- F) A polybutylene pipe or radiant panel installation without an oxygen absorption barrier is used; or
- G) Installation where the acidity of water is not within the normal Environmental Protection Agency (EPA) (between pH 6.5 – 8.5) guidelines or the water contains abnormal levels of particulate matter or water exceeding 10.5 gpg; or
- H) Element failure due to low water level, sediment accumulation in the tank or by anomalously high deposits at the surface of the elements; or
- I) The VoltMax unit is being subject to non-authorized modifications; or
- J) Defects or malfunction resulting of storing or handling done elsewhere than Thermo 2000's manufacturing plant; or
- K) Units on which the serial number is removed or obliterated



THERMO 2000 INC.

500, 9^{ième} Avenue, Richmond (Qc) Canada J0B 2H0
Tel: (819) 826-5613 Fax: (819) 826-6370
www.thermo2000.com